

AirLINE and AirLINE Quick – Modular pneumatic valve unit

- Compact design
- Modular configuration
- Higher flexibility in control cabinet due to AirLINE Quick
- Simple exchange of valves (with option “P-shut-off” – also possible during operation)

Type 8640 can be combined with...



Type 8032

Switch



Type 6212

Solenoid valve



Type 2012

Process valve



Type 8695

Control head





Type 0498



Double pilot controlled
check valve

The 8640 valve unit system is designed to solve diverse and complex control problems due to its systematic modular construction and combination of pneumatic and electrical interfaces. By putting together a row of pneumatic modules with different numbers of valves, 2 to 24 valve functionalities may be realized on one valve unit.

Electrical connectivity is achieved by either fieldbus interfaces, common connection (parallel connection technique) or multipin interfaces. The valves allow different applications to be covered. Bodies and connection modules are made of high-quality plastic (polyamide) and are easy to assemble by means of the built-in snap connectors.

Specification	Type 0460/6524/6525 	Type 6526/6527 	Type 5470 
Mounting dimensions	11 mm	16.5 mm	18 mm
Ambient temperature	0 to +55°C (by use of type 0460: 0 to +50°C)	0 to +55°C	-10 to +55°C
Pressure range	Vac. – 10 bar	Vac. – 10 bar	2 – 10 bar
Operating voltage	24 V/DC	24 V/DC	24 V/DC
Voltage tolerance	±10%	±10%	±10%
Degree of protection	3 acc. to VDE 0580	3 acc. to VDE 0580	3 acc. to VDE 0580
Duty cycle	Continuous operation (100% ED)	Continuous operation (100% ED)	Continuous operation (100% ED)
Circuit functions	C and D (3/2), H (5/2), H (5/2) Impulse, L (5/3) in middle position all ports closed N (5/3) in middle position all ports vented	C and D (3/2), H (5/2),	C and D (3/2), G (4/2),
Flow rate	300 l/min (200 l/min circuit functions H-Impulse, L and N)	700 l/min	300 l/min
Rated power	1 W	2 W, 1 W	1 W, 2 W, 3 W
No. of valve functionalities per unit	Max. 24	Max. 24	Max. 24
Feedback	Max. 32	Max. 32	Max. 32
Degree of protection	IP 20 with terminals	IP 20 with terminals	IP 20 with terminals

Continued on page 2

Specification	Type 0460/6524/6525 	Type 6526/6527 	Type 5470 
Electric Connection	<ul style="list-style-type: none"> Common connection (parallel connection) Multipin (D-Sub, 25 pole) Profibus-DP DeviceNet CANopen Internal bus extension by Profibus DP Profinet IO Ethernet I/P Modbus TCP 		
Total current with common connection with multipin connection with fieldbus connection	<p>as a function of the electrical connection technique max. 3A (sum of current through individual valves) max. 3A (sum of current through individual valves) + max. 3A (repeater) $I_{TOTAL} = I_{BASE} + (n \times I_{VALVE}) + (m \times I_{REPEATER})$ n=quantity of valves, m=quantity of repeaters, I_{VALVE}= rated current of each valve I_{REPEATER}= rated current of each repeater, m x I_{REPEATER}=max. 650 mA I_{BASE}= 200 mA spec. base current Profibus-DP 200 mA spec. base current DeviceNet</p>		

The 8640 valve island system

Solenoid valves

0460/6524/6525

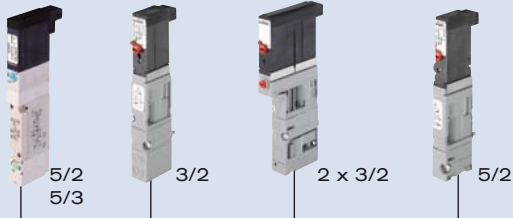

6526/6527

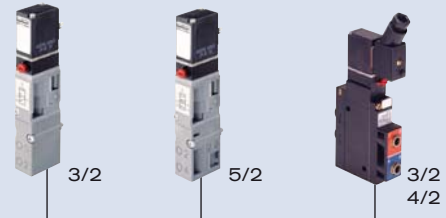

5470

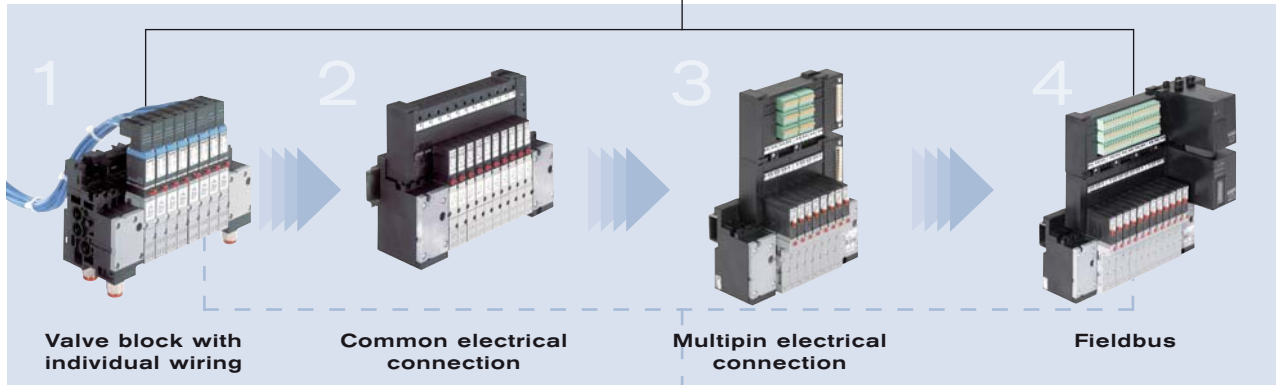

Valve block with individual wiring

Common electrical connection

Multipin electrical connection

Fieldbus



AirLINE Quick

Adapter for valve islands on the control cabinet floor or control cabinet wall

Application example

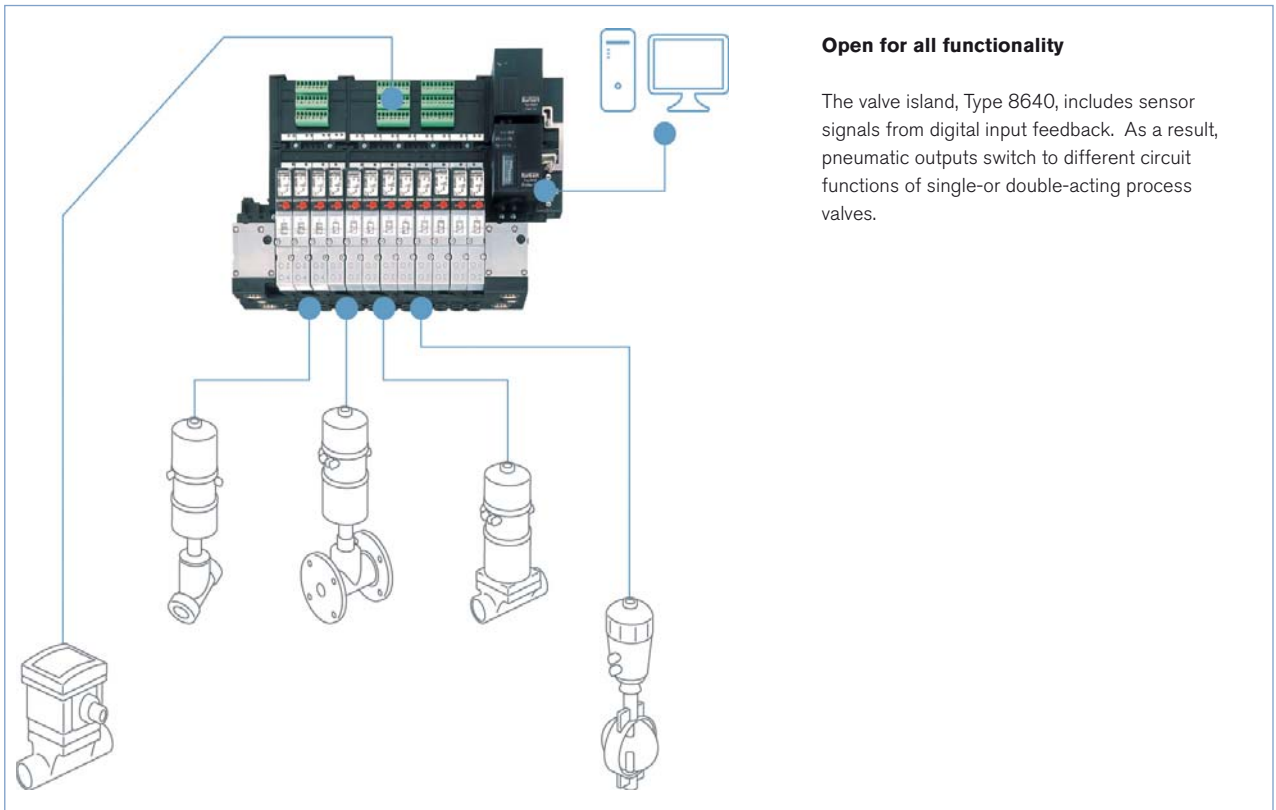

Open for all functionality

The valve island, Type 8640, includes sensor signals from digital input feedback. As a result, pneumatic outputs switch to different circuit functions of single- or double-acting process valves.

Configuration software

The 8640 valve island system is a system of modular design which can be built up to specific requirements. Bürkert offers a software program, the simple, precise generation of the required configuration of each 8640 system.

The Bürkert Configurator defines

- Number and types of valves
- Type of (intermediate) supplies
- Combination of Fieldbus, pilot valves and I/O modules

The results supplied by the Configurator

- Bill of materials
- Illustration
- Drawings
- 2D / 3D CAD data

For more information consult individual datasheets, downloadable at www.burkert.com

Examples 2D / 3D CAD data

Example 3D CAD model in 3D-Pdf format

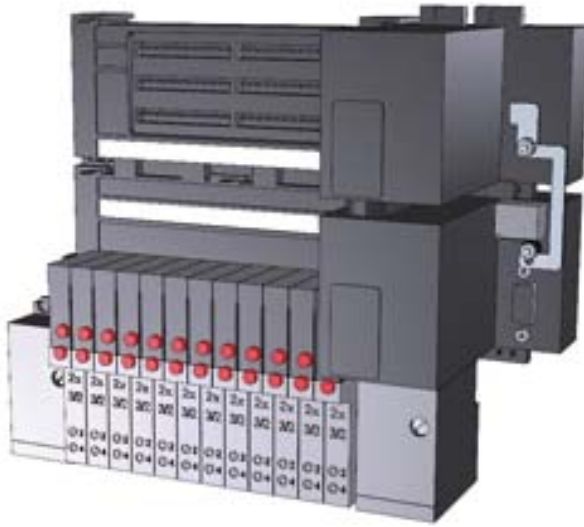

Examples 2D DXF drawings in different views

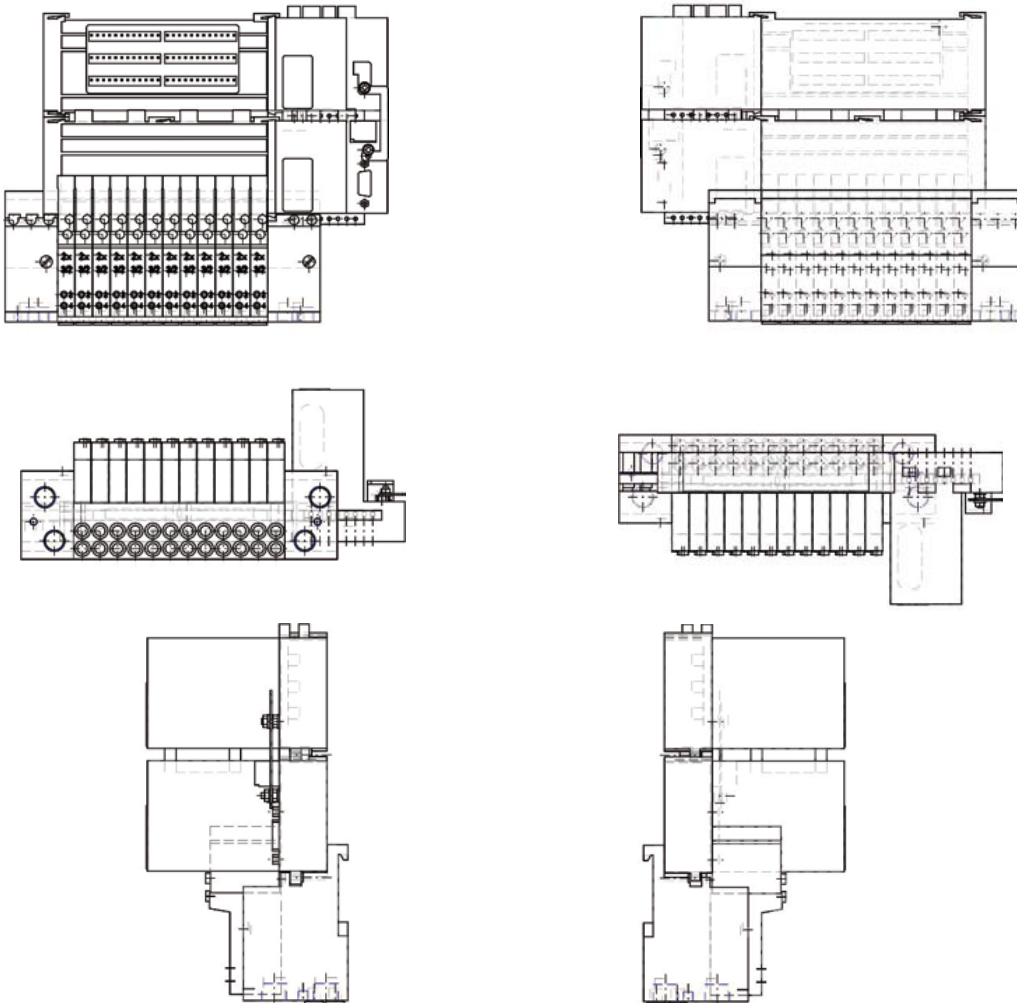

11mm width per station Multi-way solenoid valve Types 6524 and 6525



The solenoid valve Types 6524 and 6525 consist of a 6144 flipper pilot valve and a pneumatic seat valve. The flipper principle allows switching of high pressure at low power consumption and fast response times. The pilot valves are equipped with manual override as a standard. The 2x3/2 way valve version is a combination of two flipper pilot valves type 6144 and a pneumatic seat valve.

Spezifikationen	3/2-way valve	2 x 3/2-way valve
Body material	PA (polyamide)	
Seal material	FPM, NBR	
Media	Lubricated and non-lubricated dry air, neutral gases (5 µm-Filter)	
Port connection	Flange for MP11	
Pneumatic module	Type MP11 with push-in connection dimension 6 mm, D1/4, M7	
Manual override	As a standard feature	
Voltage	24 V DC *	
Nominal power	0.8 W	2 x 0.8 W with reduction of power consumption
Duty cycle	Continuous operation (100% ED)	
Elec. connection on valve	Rectangular plug 2-pole with raster 5.08 mm	Rectangular plug 3-pole with raster 2.54 mm
Mounting	With 2 screws M2 x 20	With 2 screws M2 x 28
Installation position	As required, preferably with pilot valve upright	
Flow rate: QNn value air [l/min]	Measured at +20°C, 6 bar pressure at valve inlet and 1 bar pressure difference	
Pressure ranges [bar]	Measured as overpressure to the atmospheric pressure	
Response times [ms]	Measured according to ISO 12238	

* 10% residual ripple allowed

Order chart for valves

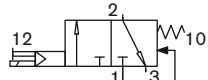
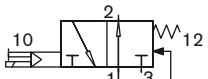
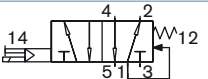
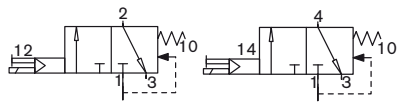
Circuit function	Orifice [mm]	QNn value air [l/min]	Pressure range [bar]	Response times		Voltage/Frequency [V/Hz]	Item no.
				Opening [ms]	Closing [ms]		
Circuit function C  3/2-way valve, servo-assisted in de-energized position port 2 to atmosphere	4	300	Vak.-7	15	20	24 V DC *	186 258
			1-10 ¹⁾	15	20	24 V DC *	186 257
			2.5-10	15	28	24 V DC *	184 043
Circuit function D  3/2-way valve, servo-assisted in de-energized position port 2 pressurized			2.5-10	15	28	24 V DC *	184 400
Circuit function H  5/2-way valve, servo-assisted in de-energized position port 1 connected to port 2, port 4 exhausted	4	300	1.0-10 ¹⁾	15	20	24 V DC *	186 271
			2.5-10	20	28	24 V DC *	179 938
Circuit function C  2 x 3/2-way valve, servo-assisted in de-energized position port 2/4 to atmosphere	4	300	1.0-10 ¹⁾	12	20	24 V DC *	186 259 ²⁾
			2.5-10	12	20	24 V DC *	186 260 ²⁾

¹⁾ Version with auxiliary air.

²⁾ Version with integrated reduction of power consumption

* 10% residual ripple allowed

11 mm Anreihmaß: pilot valve Type 0460



The solenoid valve Type 0460 consists of a pneumatic valve body fitted with a double coil pilot valve. The principle allows switching of high pressures together with low power consumption and fast response times. All valves are equipped with manual override as a standard.

Technical data	
Body material	aluminium
Seal material	NBR
Medium	lubricated and non lubricated dry compressed air; neutral gases (5 µm-filter recommended)
Port connection	Flange
Pneumatic module	MP11
Supply port connection 1 (P), 3 (R), 5 (S)	G 1/4 NPT 1/4
Service port 2 (A), 4 (B)	push-in connection Ø 6 mm push-in connection Ø 1/4" Threaded port M7
Operating voltages	24 V/DC
Electrical connection at the valve	Rectangular plug
Manual override	standard
Flow rate: QNn value Air [l/min]	Measured at +20°C, 6 bar pressure at valve inlet and 1 bar pressure difference
Pressure values [bar]	Measured as overpressure to the atmospheric pressure
Response times [ms]	Measured according to ISO 12238

Order chart for valves

Circuit function	Orifice [mm]	QNn value air [l/min]	Pressure range [bar]	Nominal power [W]	Response times		Item no.
					Opening [ms]	Closing [ms]	
<p>5/2-way valve, servo-assisted, Impulse version</p>	2,5	200	2,0-7,0	1	15	15	154 183
<p>5/3-way-valve, pilot-controlled, in middle position all ports locked</p>	2,5	200	2,0-7,0	1	15	20	154 184
<p>5/3-way-valve, pilot-controlled, in middle position port 2 and 4 exhausted</p>	2,5	200	2,0-7,0	1	15	20	154 185

16.5mm width per station Multi-way for solenoid valve Types 6526 and 6527



The solenoid valve Types 6526 and 6527 consist of a pneumatic valve body fitted with Type 6106 rocker pilot valve. The rocker principle allows switching of high pressure at low power consumption and fast response times. The pilot valves are equipped with manual override as a standard.

Specification	
Body material	PA (polyamide)
Seal material	NBR
Media	Lubricated and non-lubricated dry air, neutral gases (10 µm filter)
Port connection	Flange for MP12
Pneumatic modules	Type MP12 with G 1/8, NPT 1/8 Plug-in coupling Ø 8 mm
Manual override	Standard
Voltage	24 V DC
Nominal power	2 W, 1W
Duty cycle	Continuous operation (100% ED)
Elec. Connection on valve	Tag connector acc. to DIN EN 175301-803 (previously DIN 43650) Form C
Mounting	With 2 screws M3x30
Installation position	As required, preferably with pilot valve upright
Flow rate: QNn value air [l/min]	Measured at +20°C, 6 bar pressure at valve inlet and 1 bar pressure difference
Pressure ranges [bar]	Measured as overpressure to the atmospheric pressure
Response times [ms]	Measured acc. to ISO 12238

Order chart for valves

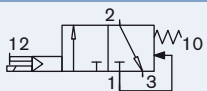
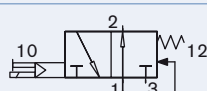
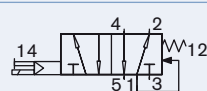
Circuit function	Orifice [mm]	QNn value air [l/min]	Pressure range [bar]	Nominal power [W]	Response times			Item no.
					Opening [ms]	Closing [ms]	Voltage/Frequency [V/Hz]	
C  3/2-way valve, servo-assisted in de-energized position port 2 to atmosphere	6	700	1,0 - 10 ¹⁾	2	20	12	24 V DC	156 842
			1,0 - 10 ¹⁾	2	20	12	24 V DC	163 028 ²⁾
			2,0 - 10	2	20	12	24 V DC	156 318
			2,0 - 10	2	20	12	24 V DC	158 944 ²⁾
			2,0 - 8,0	1	20	17	24 V DC	156 840
			2,0 - 8,0	1	20	12	24 V DC	158 947 ²⁾
D  3/2-way valve, servo-assisted in de-energized position port 2 pressurized	6	700	1,0 - 10 ¹⁾	2	20	12	24 V DC	163 029 ²⁾
			2,0 - 10	2	12	20	24 V DC	156 320
			2,0 - 10	2	20	12	24 V DC	158 946 ²⁾
			2,0 - 8,0	1	17	20	24 V DC	156 841
H  5/2-way valve, servo-assisted in de-energized position port 1 connected to port 2, port 4 exhausted	6	700	1,0 - 10 ¹⁾	2	20	12	24 V DC	156 828
			1,0 - 10 ¹⁾	2	20	12	24 V DC	163 030 ²⁾
			2,0 - 10	2	20	12	24 V DC	156 337
			2,0 - 10	2	20	12	24 V DC	158 942 ²⁾
			2,0 - 8,0	1	20	17	24 V DC	156 827
			2,0 - 8,0	1	20	12	24 V DC	158 943 ²⁾

¹⁾ version with auxiliary air

²⁾ electric connection with manual override.

³⁾ closing time approx. 5 ms higher when used together with valve unit

More valve options

Covering plates

When all the valve connections in a basic valve unit module are not used, then these connections should be covered by the appropriate covering plate for full efficiency.

Covering plates	Item no.
Covering plate for solenoid valve Type 6524/6525	650 373
Covering plate for solenoid valve Type 6524 2 x 3/2-way valve	661 092
Covering plate for solenoid valve Type 6526/6527	653 765

Exhaust plates

An exhaust plate is mounted on the pneumatic module of the valve unit and offers an additional possibility to remove compressed air from the system.

Exhaust plates	Item no.
Exhaust air plate complete Type 6524/6525	655 166
Exhaust air plate complete Type 6526/6527	653 697

18 mm Anreihmaß Magnetventil 5470



The solenoid valve Type 5470 consist of a pneumatic valve body fitted with type 6106 rocker pilot valve.

An armature with a tilting bearing, similar o a rocker, tilts within the body of the pilot valve, and switches the valve. The minimal tilting movement of the rocker is non-wearing, and basic lubrication is unnecessary.

The type 5470 R is available as a 3/2 and 4/2-way valve. The valves can be mounted together individually using the module flange. In various applications, they can be used advantageously as valve blocks. Different variants are available for service ports 2 and 4.

Specification	
Orifice	DN 4.0
Body material	Polyamid (PA)
Valve internal	Ultramid
Seal material	NBR
Media	Compressed air, neutral gases (5 µm-filter)
Medium temperature	-10 ... +50 °C
Ambient temperature	-10 ... +55 °C
Supply port connections 1 and 3	Module flange
Service port connections 2 and 4 (variants)	Threaded port G 1/8 Threaded port NPT 1/8 Tube connection SL 6/4 mm Push-in Ø 6 mm
Operating voltages	24 V DC, 110 - 120 V DC, 220 - 240 V DC, (for alternating current, use valves with UC-coil)
Voltage tolerance	±10 %
Duty cycle	Continuous operation
Elec. Connection on valve	Tag connector acc. to DIN 43 650 Form C, for Cable Plug type 1057 and type 2506 (see accessory); Rectangular plug (5.08)
Ignition protection	EEx ia IIC T6 on request
Type of protection	IP 65 (with cable plug)
Installation position	As required, preferably with pilot valve upright

Order chart for valves

Circuit function	Orifice [mm]	Q _{Nn} value air [l/min]	Service ports 4 and 2	Pressure range [bar]	Nominal power [W]	Voltage/Frequency [V/Hz]	Item no. (Valve island)	Item no. (Valve block)
	4	300	Push-in ø 6 mm, below	2 - 8	1	24 V DC	132 479	135 203
				2 - 10	2	24 V DC	133 148	135 204
				2 - 10	3	110 - 120 DC		132 952
				2 - 10	3	220 - 240 DC		132 953
	4	300	Push-in ø 6 mm, below	2 - 8	1	24 V DC	132 481	136 742
				2 - 10	2	24 V DC	136 741	136 743
				2 - 10	3	110 - 120 DC		136 744
				2 - 10	3	220 - 240 DC		136 745
	4	300	Push-in ø 6 mm, front	2 - 8	1	24 V DC	132 487	135 205
				2 - 10	2	24 V DC	133 149	135 206
				2 - 10	3	110 - 120 DC		132 954
				2 - 10	3	220 - 240 DC		132 955
	4	300	Push-in ø 6 mm, below	2 - 8	1	24 V DC	132 489	135 207
				2 - 10	2	24 V DC	133 150	135 208
				2 - 10	3	110 - 120 DC		132 956
				2 - 10	3	220 - 240 DC		132 957
	4	300	Push-in ø 6 mm, front with throttle-check valve	2 - 8	1	24 V DC	132 488	135 209
				2 - 10	2	24 V DC	133 151	135 210
				2 - 10	3	110 - 120 DC		133 152
				2 - 10	3	220 - 240 DC		133 153

Continued on page 9

Order chart for valves, continued

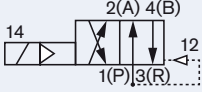
Circuit function	Orifice [mm]	Q _N value air [l/min]	Service ports 4 and 2	Pressure range [bar]	Nominal power [W]	Voltage/Frequency [V/Hz]	Item no. (Valve island)	Item no. (Valve block)
G 	4	300	Threaded port G 1/8, front	2 - 8	1	24 V DC	132 483	135 211
				2 - 10	2	24 V DC	133 157	135 212
				2 - 10	3	110 - 120 DC		132 958
				2 - 10	3	220 - 240 DC		132 959
	4	300	Threaded port G 1/8, front, with throttle-check valve	2 - 8	1	24 V DC	132 484	135 213
				2 - 10	2	24 V DC	133 159	135 214
				2 - 10	3	110 - 120 DC		133 160
				2 - 10	3	220 - 240 DC		133 161
	4	300	Tube connection SL6/4 mm, front	2 - 8	1	24 V DC	133 162	135 215
				2 - 10	2	24 V DC	133 163	135 216
				2 - 10	3	110 - 120 DC		133 164
				2 - 10	3	220 - 240 DC		133 166

¹⁾ In operation of alternating current (AC), place a cable plug type 2506 with rectifier upstream.

Composition valve block & valve island

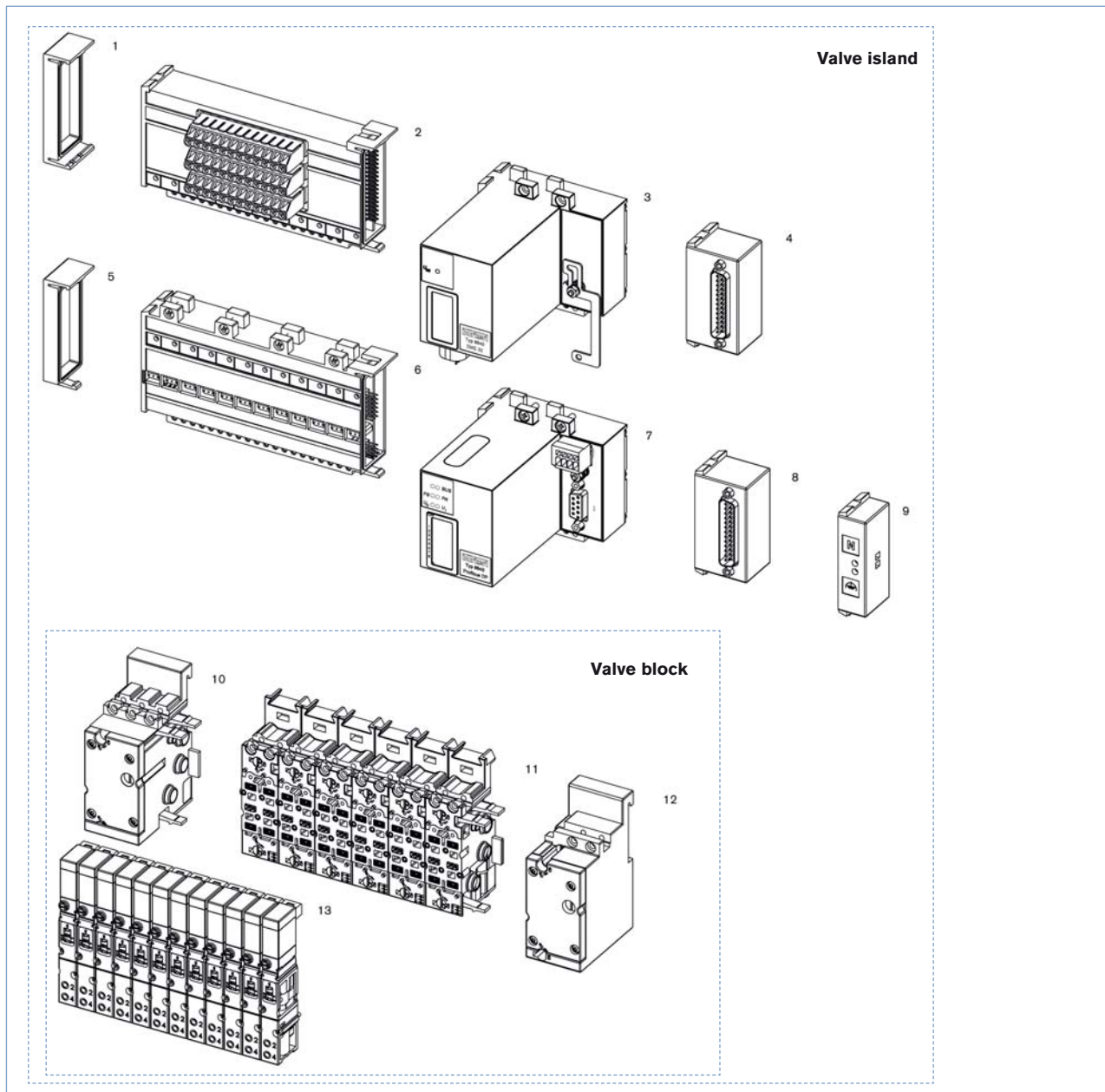

Basic module choice, for further modules see the following pages

- | | |
|--|--|
| 1. Electrical end module left | 2. Terminal module for electronic inputs |
| 3. Extension module for electrical inputs | 4. Multipin repeater inputs (initiators) |
| 5. Electrical end module left | 6. Basic electrical module standard |
| 7. Fieldbus module | 8. Multipin valve outputs |
| 9. Common connection module | 10. Pneumatic connection module left, Type MP11 |
| 11. Basic pneumatic modules, Type MP11 for 12 valves | 12. Pneumatic connection module right, Type MP11 |
| 13. Valves of Type 6525 (5/2-way) | |

Module description

Collective line- and multipol-modules
for single connection of valves and feedback

 0460/6524/6525 width/station 11mm	 6526/6527 width/station 16,5mm	 5470 width/station 18mm
--	---	--

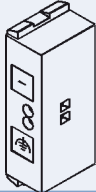

Connection via individual stranded wires

- Looped-through ground potential
- Max. 24 valves
- IP20 degree of protection
- Screw terminal

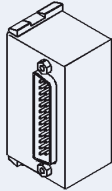
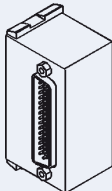
<p>Multipin module Valve outputs</p> 	<p>Multipin module Repeater inputs (initiators)</p> 
---	---

Fieldbus modules

 0460/6524/6525 width/station 11mm	 6526/6527 width/station 16,5mm	 5470 width/station 18mm
---	--	---

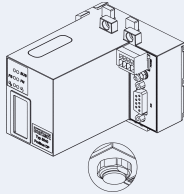

Fieldbus PROFIBUS-DP, IP20 degree of protection

- Max. 24 valves
- Max. 32 repeaters (in connection with EME module)
- Transmission rates 9.6; 19.2; 93.75; 187.5; 500 kBaud; 1.5; 3; 6; 12 MBaud
- Power supply with rectangular plug (4-pole male)
- Bus connection D-SUB (9-pole female)
- With RIO-connection M8 (4-pole)

Internal bus extension RIO-VA module, IP20 degree of protection

- Max. 24 valves
- Max. 32 repeaters (in connection with EME module)
- Plug connection
- RIO cable for bus extension 1m (Item no. 917 498)
2m (Item no. 917 498)

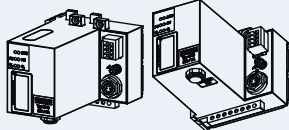

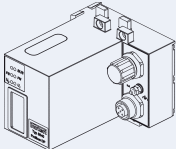



Fieldbus PROFIBUS-DP IP54 degree of protection
on connection with the basic electrical module the complete system meets the degree of protection IP54

- Max. 24 valves
- Max. 32 repeaters (in connection with EME module)
- Transmission rates 9.6; 19.2; 93.75; 187.5; 500 kBaud; 1.5; 3; 6; 12 MBaud
- Power supply with M12 circular plug (4-pole male)
- Bus connection M12 (5-pole female)
- For a trouble-free assembly use the following Y-piece (Item no. 902 098)

Module description

Fieldbus modules

		
0460/6524/6525 width/station 11mm	6526/6527 width/station 16,5mm	5470 width/station 18mm

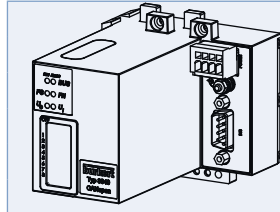

Fieldbus CANopen, IP20 degree of protection

Max. 24 valves,
Max. 32 repeaters (in connection with EME module)
Transmission rates 20, 125, 250 or 500 kBaud
Power supply with rectangular plug (4-pole)
Bus connection D-SUB (9-pole male)

Fieldbus CANopen, IP54 degree of protection on connection with the basic electrical module the complete system meets the degree of protection IP54

Max. 24 valves
Max. 32 repeaters (in connection with EME module)
Transmission rates 20, 125, 250 or 500 kBaud
Power supply with M12 circular plug (4-pole male)
Bus connection M12 (5-pole male)
For a trouble-free assembly use the following Y-piece (Item no. 788 643)

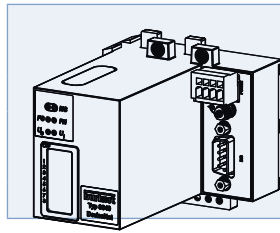
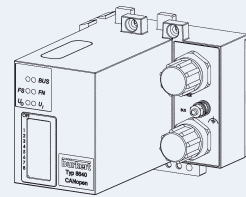

Fieldbus Device Net, IP20 degree of protection

Max. 24 valves
Max. 32 repeaters (in connection with EME module)
Transmission rates 125, 250 or 500 kBaud
Power supply with rectangular plug (4-pole)
Bus connection D-Sub (9-pole male)

Fieldbus Device Net, IP54 degree of protection on connection with the basic electrical module the complete system meets the degree of protection IP54

Max. 24 valve
Max. 32 repeaters (in connection with EME module)
Transmission rates 125, 250 or 500 kBaud
Power supply with M12 circular plug (4-pole male)
Bus connection M12 (5-pole male)
For a trouble-free assembly use the following Y-piece (Item no. 788 643)

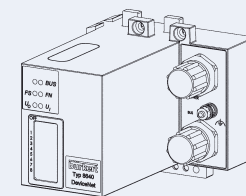

Module description

Fieldbus modules

 0460/6524/6525 width/station 11mm	 6526/6527 width/station 16,5mm	 5470 width/station 18mm
--	---	--

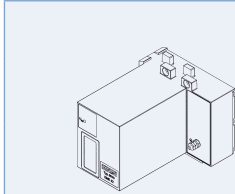

EME module (extension module inputs), IP54 degree of protection

Module for connection of repeater inputs
in connection with fieldbus modules

Fieldbus Profinet IO, Ethernet I/P, Modbus TCP Protection class IP20

Max. 24 valves

Max. 32 repeaters (in connection with EME-module)

Transmission rates 10/100 Mbits/s with auto crossover

Power supply with rectangular plug (4-pole)

Bus connection RJ45 (2x)

RIO-connection M8 (4-pole)

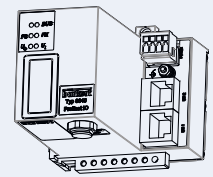

Further electrical accessories

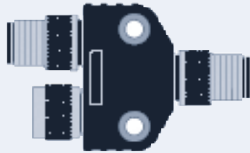

Bus Y-piece for PROFIBUS

You must use one pre-assembled plug and one plug for free assembly.
(Item no. 902 098)

(Item no. 788 643) **Bus Y-piece for CANopen and DeviceNet**

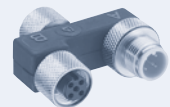

AirLINE Quick

With AirLINE Quick you can reduce the amount of the components in the control cabinet considerably. With the AirLINE Quick Adapter the valve island is directly adapted on the control cabinet floor or wall.

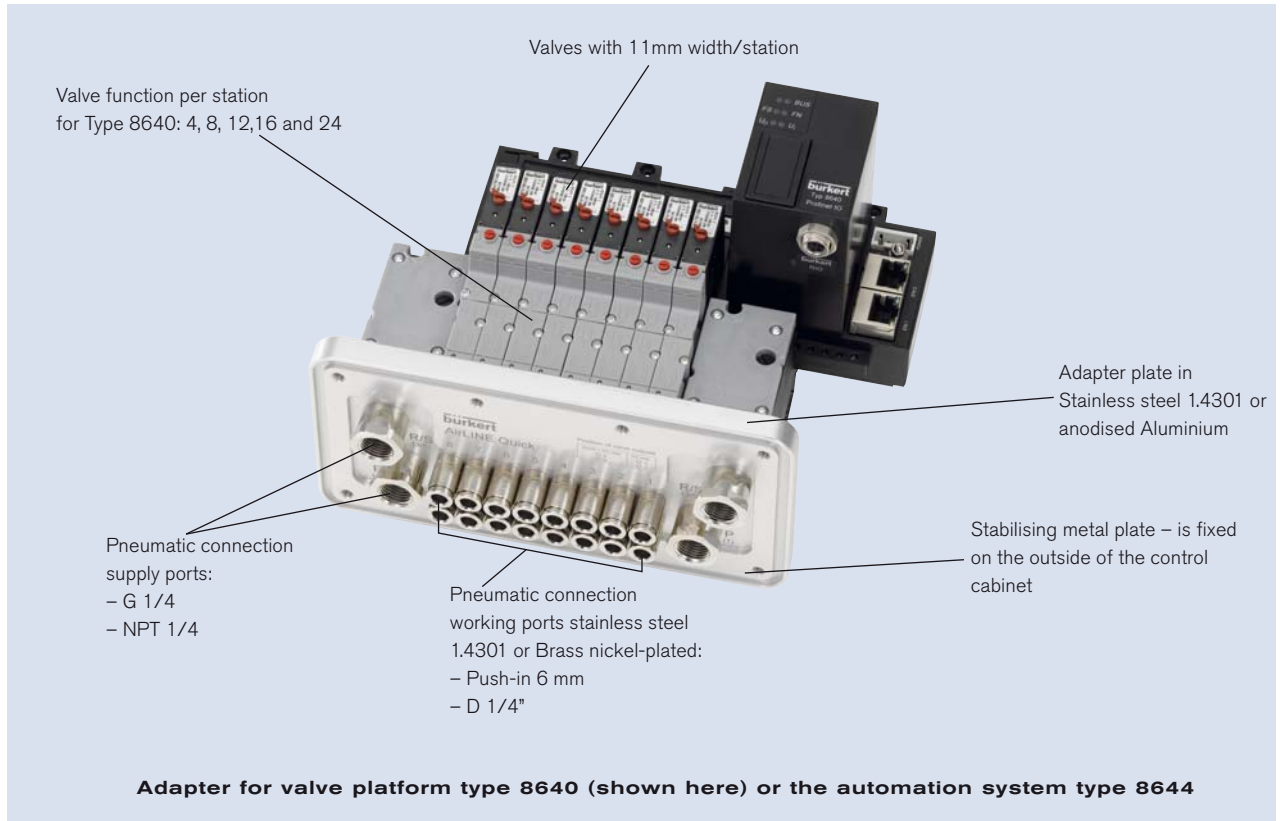

* Valves of type 0460 cannot be installed with AirLINE Quick due to the size.

Technical data

Technical data	
Material for AirLINE Quick Adapter	Stainless steel 1.4301 anodised Aluminium
Material Pneumatic connection	Stainless steel 1.4301 Brass nickel-plated
Pneumatic connection, supply ports	G 1/4, NPT 1/4
Pneumatic connection working ports	Push-in D6 mm, D1/4"
Installation	Control cabinet wall Control cabinet floor
Valve function per station	4, 8, 12, 16 and 24

Additional accessories for AirLINE Quick

Blanking plate

A blanking plate is used to cover an existing flange for AirLINE Quick on the cabinet wall or on the cabinet floor.

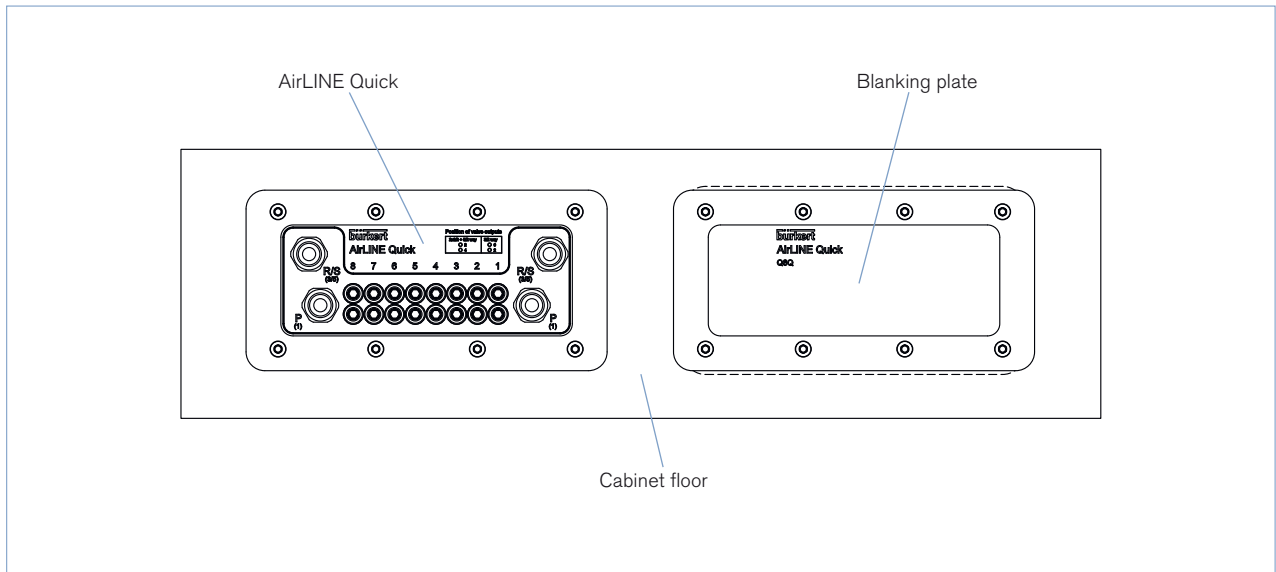

Order chart blanking plate

Material	Amount of valve slots	Item no.
Aluminium anodised	4	246 937
	8	246 933
	12	246 929
	16	246 925
Stainless steel 1.4301	4	246 938
	8	246 934
	12	246 930
	16	246 926

To find your nearest Bürkert facility, click on the orange box →

www.buerkert.com

In case of special application conditions, please consult for advice.

Subject to alteration
© Christian Bürkert GmbH & Co. KG

1310/8_EUen_00891940