

2/2-way Globe Valve for media up to +180 °C, DN 10-100



- Compact globe valve version
- Flange, threaded and welded ports as standard
- Stainless steel 316L valve body
- Available with flow direction below and above seat

Type 2012 can be combined with...



Type 8691

Control head



Type 8690

Pneum. control unit with feedback



Type 1062

Electrical position feedback

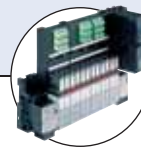

Type 8640/8644

Valve block

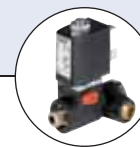

Type 6012/6014 P

Pilot valve



Type 5470

Solenoid valve

The externally piloted globe valve consists of a pneumatically operated piston actuator and a 2/2-way valve body. The actuator is made of PA or, for special operating conditions, PPS. The reliable self-adjusting packing gland provides high sealing integrity. These maintenance-free and robust valves can be retro-fitted with a comprehensive range of accessories for position indication, stroke limitation or manual override.

²⁾ **Note:** For PA actuators in the sizes 40, 50 and 63, the combination of max. media temperature and max. ambient temperature is as shown in the following chart:

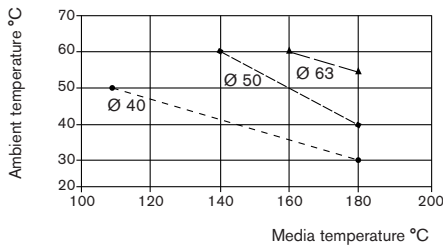

Technical data	
Orifice	DN 10-100
Body material	Cast stainless steel 316L
Actuator material	PA, PPS
Seal material	PTFE (NBR, FKM and EPDM on request)
Medium	Water, alcohol, oils, fuel, salt solution, alkali solutions, organic solvents, steam
Viscosity	Max. 600 mm ² /s
Packing gland (with silicone grease)	PTFE
Nominal pressure	PN 25 (body)
Medium temperature ²⁾	-10 to +180 °C with PTFE seal
Ambient temperature PA actuator ¹⁾	
Actuator sizes up to Ø 125	-10 to +60 °C
Actuator sizes Ø 175-225	-10 to +50 °C
PPS actuator	
Actuator sizes Ø 40-80	+5 to +140 °C
Actuator sizes Ø 100-125	+5 to +90 °C
Installation	As required, preferably with actuator in upright position
Control medium	Neutral gases, air
Max. pilot pressure	
Actuator size Ø 40 - 80	PA and PPS 10 bar
Actuator size Ø 100	PA 10 bar
Actuator size Ø 100	PPS 7 bar
Actuator size Ø 125	PA and PPS 7 bar
Actuator size Ø 175-225	PA 6 bar

Content

Valve specifications	System spec. On/Off Classic	Request for quotation
 Type 2012	 Type 8801-GA/ 8803-GA	Type 8801-GA/ 8803-GA
Technical data & ordering info. p. 1-14	Ordering info. & technical data p. 15-18	p. 19

Materials

Actuator size 40-125 mm

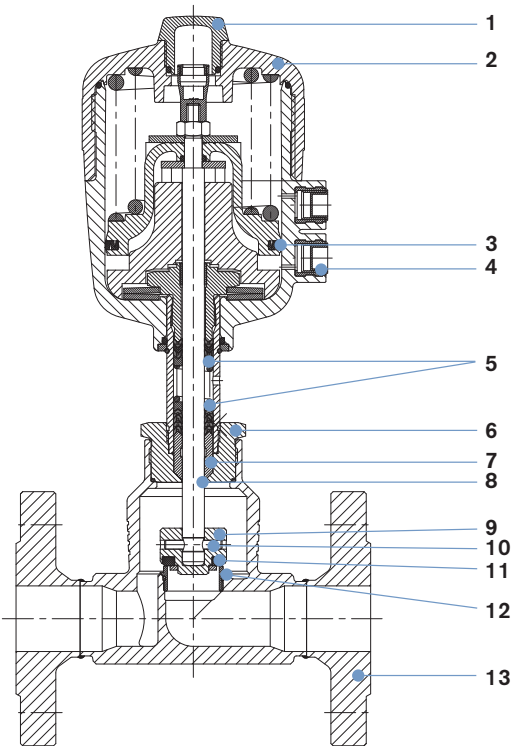

- | | | | |
|----|----|-----------------|------------------------------------------------------------------|
| 1 | 1 | Transparent cap | PC, PSU |
| 2 | 2 | Actuator | PA, PPS |
| 3 | 3 | Cylinder seal | NBR, FKM |
| 4 | 4 | Pilot air ports | Stainless steel 1.4305 |
| 5 | 5 | V-seals | PTFE, FKM |
| 6 | 6 | Nipple | Stainless steel 1.4401 |
| 7 | 7 | Wiper | - PTFE |
| 8 | 8 | Spindle | - PEEK Actuator size 100 mm and 125 mm
Stainless steel 1.4401 |
| 9 | 9 | Swivel plate | Stainless steel 1.4401 |
| 10 | 10 | Pin | Stainless steel 1.4401 |
| 11 | 11 | Seal | PTFE (NBR, FKM, EPDM on request) |
| 12 | 12 | Valve seat | Stainless steel 1.4571 |
| 13 | 13 | Valve body | Stainless steel 316L |

Actuator size 175 and 225mm

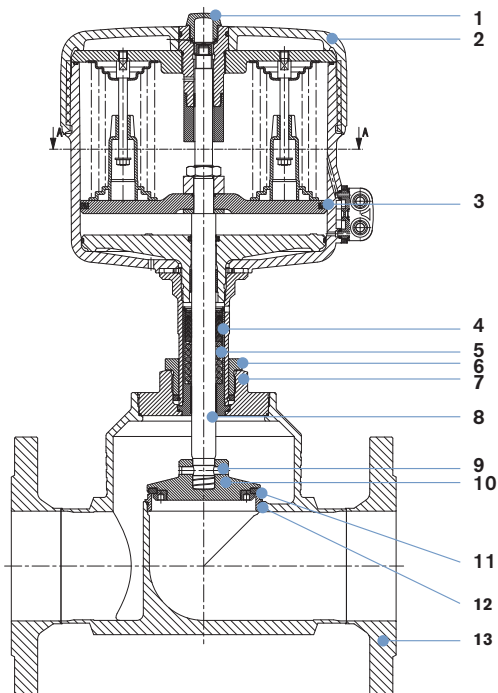

- | | | | |
|----|----|-----------------|----------------------------------|
| 1 | 1 | Transparent cap | PC |
| 2 | 2 | Actuator | PA |
| 3 | 3 | Cylinder seal | NBR |
| 4 | 4 | V-seals | PTFE |
| 5 | 5 | Spring | Stainless steel 1.4568 |
| 6 | 6 | Screw | Stainless steel 1.4305 |
| 7 | 7 | Nipple | Stainless steel 1.4404 |
| 8 | 8 | Spindle | Stainless steel 1.4401 |
| 9 | 9 | Pin | Stainless steel 1.4404 |
| 10 | 10 | Swivel plate | Stainless steel 1.4404 |
| 11 | 11 | Seal | PTFE (NBR, FKM, EPDM on request) |
| 12 | 12 | Valve seat | Stainless steel 1.4571 |
| 13 | 13 | Valve body | Stainless steel 316L |

Technical data for valves with flow direction below the seat

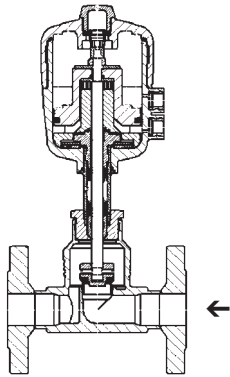

Flow direction below seat
Type 2012 with flange port connection

Orifice [mm]	Actuator size [mm]	Kv value water (m ³ /h)	Minimum pilot pressure CFA [bar]	Maximum operating pressure up to +180°		Weight with CFA Flange [kg]	Threaded port and weld end [kg]
				CFA [bar]	CFB [bar]		
10	40	4.7	4.0	15	16	2.3	0.8
	50	4.7	3.9	16	16	2.4	0.9
15	40	4.7	4.0	15	16	2.3	0.8
	50	4.7	3.9	16	16	2.4	0.9
20	40	8.1	4.0	6.5	16	3.1	0.9
	50	8.1	3.9	11	16	3.3	1.1
	63	8.1	4.5	16	–	3.7	1.5
25	63	13.0	4.5	11	16	4.6	2.0
	80	13.0	5.0	16	–	5.4	2.8
32	63	19.5	4.5	6	16	6.6	2.9
	80	19.5	5.0	14	–	7.4	3.7
40	80	31.0	5.0	9	16	8.4	4.2
	125	31.0	3.2	16	–	13.9	9.7
50	100	45.0	4.4	7.2	16	13.5	7.7
	125	45.0	3.2	10	–	15.6	9.8
65	125	73.0	5.6	12	15	20.2	12.9
	175	73.0	4.5	15	–	26	18.7
80	125	110.0	5.6	7.5	12.5	24.5	16.1
	175	110.0	4.5	10	–	30	21.3
	225	110.0	3.3	12.5	–	35.5	26.9
100	125	165.0	5.6	5	9	32.9	20.6
	175	155.0	4.5	7	10	37.9	25.6
	225	155.0	4.8	10	–	43.5	31.2

Pressure charts for control function B and flow direction below the seat

DN 10-20

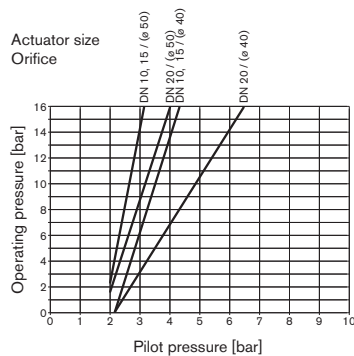

DN 25-50

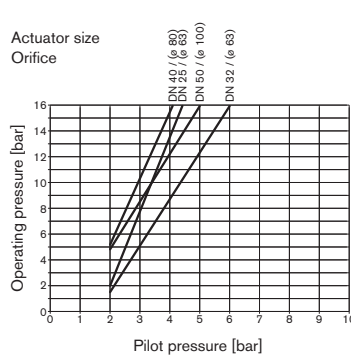

DN 65-100

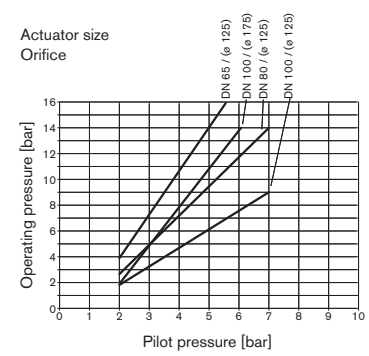

Ordering chart for valves with flow direction below the seat (other versions on request)

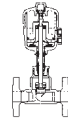

Valves with stainless steel body and flange connection according to DIN EN 1092-1, flow below seat

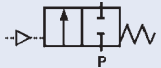
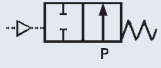
Control function	Orifice [mm]	Actuator size Ø [mm]	Kv value water [m³/h]	Minimum pilot pressure [bar]	Operating pressure up to +180 °C [bar]	Item no. PA actuator	Item no. PPS actuator
 2/2-way valve, NC by spring action	10	40	4.7	4.0	15	146 227	146 362
		50	4.7	3.9	16	146 237	146 370
	15	40	4.7	4.0	15	146 247	–
		50	4.7	3.9	16	146 259	146 378
		63	8.1	4.5	16	146 295	146 390
	20	40	8.1	4.0	6.5	146 271	–
		50	8.1	3.9	11	146 283	–
	25	63	13.0	4.5	11	146 299	–
		80	13.0	5.0	16	146 310	146 398
	32	63	19.5	4.5	6	146 314	–
		80	19.5	5.0	14	146 322	146 406
	40	80	31.0	5.0	9	146 327	–
		125	31.0	3.2	16	146 339	146 414
	50	100	45.0	4.4	7.2	146 345	–
		125	45.0	3.2	10	146 357	146 422
	65	125	73.0	5.6	12	152 743	156 476
		175	73.0	4.5	15	152 761	–
	80	125	110.0	5.6	7.5	155 527	156 484
		175	110.0	4.5	10	152 779	–
		225	110.0	3.3	12.5	152 797	–
100	125	165.0	5.6	5	155 546	156 492	
	175	155.0	4.5	7.0	152 815	–	
	225	155.0	4.8	10	152 833	–	
 2/2-way valve, NO by spring action	10	40	4.7	see charts page 3	16	146 232	146 366
		50	4.7		16	146 242	146 374
	15	40	4.7		16	146 253	–
		50	4.7		16	146 265	146 382
	20	40	8.1		16	146 277	–
		50	8.1		16	146 289	146 386
	25	63	13.0		16	146 305	146 394
	32	63	19.5		16	146 318	146 402
	40	80	31.0		16	146 333	146 410
	50	100	45.0		16	146 351	146 418
	65	125	73.0		15	152 752	156 480
	80	125	110.0		12.5	152 770	156 488
	100	125	165.0		9	152 806	156 496
		175	155.0		10	152 824	–

Further versions on request



Port connections

Flange acc. to ANSI, JIS
Clamp



Control function

I (double-acting actuator)



Approvals

GL, EC Gas Appliances Directive (previously DVGW), SIL



Mediums temperature

Valves for mediums temperature up to +200°C or down to -40°C

Ordering chart for valves with flow direction below the seat (other versions on request), cont.

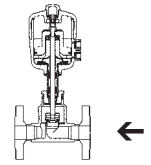

Valves with stainless steel body and threaded port connection, flow below seat

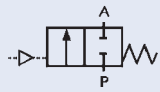
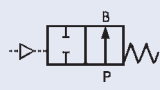
Control function	Orifice [mm]	Threaded port connection	Actuator size Ø [mm]	Kv value water [m³/h]	Minimum pilot pressure [bar]	Operating pressure up to +180 °C [bar]	Item no. PA actuator	Item no. PPS actuator
A  2/2-way valve, NC by spring action	10	G 3/8	40	4.7	4.0	15	146 228	146 363
			50	4.7	3.9	16	146 238	146 371
	15	G 1/2	40	4.7	4.0	15	146 248	–
			50	4.7	3.9	16	146 260	146 379
			63	8.1	4.5	16	146 296	146 391
	20	G 3/4	40	8.1	4.0	6.5	146 272	–
			50	8.1	3.9	11	146 284	–
			63	8.1	4.5	16	146 296	146 391
	25	G 1	63	13.0	4.5	11	146 300	–
			80	13.0	5.0	16	146 311	146 399
	32	G 1 1/4	63	19.5	4.5	6	146 315	–
			80	19.5	5.0	14	146 323	146 407
40	G 1 1/2	80	31.0	5.0	9	146 328	–	
		125	31.0	3.2	16	146 340	146 415	
		125	45.0	3.2	10	146 358	146 423	
65	G 2	100	45.0	4.4	7.2	146 346	–	
		125	45.0	3.2	10	146 358	146 423	
65	G 2 1/2	125	65.0	5.6	12	152 745	156 477	
		175	65.0	4.5	15	152 763	–	
B  2/2-way valve, NO by spring action	10	G 3/8	40	4.7	see charts page 3	16	146 233	146 367
			50	4.7		16	146 243	146 375
	15	G 1/2	40	4.7		16	146 254	–
			50	4.7		16	146 266	146 383
	20	G 3/4	40	8.1		16	146 278	–
			50	8.1		16	146 290	146 387
	25	G 1	63	13.0		16	146 306	146 395
	32	G 1 1/4	63	19.5		16	146 319	146 403
	40	G 1 1/2	80	31.0		16	146 334	146 411
	50	G 2	100	45.0		16	146 352	146 419
	65	G 2 1/2	125	65.0		15	152 754	156 481

i Further versions on request

Port connections
 Threaded port NPT, Rc
 Clamp

Control function
 I (double-acting actuator)

Approvals
 GL, EC Gas Appliances Directive (previously DVGW), SIL

Mediums temperature
 Valves for mediums temperature up to +200°C or down to -40°C

Ordering chart for valves with flow direction below the seat (other versions on request), cont.

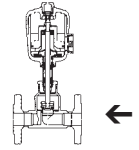

Valves with stainless steel body and weld end according to EN ISO 1127/ISO 4200, flow below seat

Control function	Orifice [mm]	Weld end EN ISO 1127/ ISO 4200 external Ø x Ws [mm]	Actuator size Ø [mm]	Kv value water [m ³ /h]	Minimum pilot pressure [bar]	Operating pressure up to + 180 °C [bar]	Item no. PA actuator	Item no. PPS actuator
<p>2/2-way valve, NC by spring action</p>	10	17.2 x 1.6	40	4.7	4.0	15	146 229	146 364
			50	4.7	3.9	16	146 239	146 372
	15	21.3 x 1.6	40	4.7	4.0	15	146 249	–
			50	4.7	3.9	16	146 261	146 380
	20	26.9 x 1.6	40	8.1	4.0	6.5	146 273	–
			50	8.1	3.9	11	146 285	–
			63	8.1	4.5	16	146 297	146 392
	25	33.7 x 2.0	63	13.0	4.5	11	146 301	–
			80	13.0	5.0	16	146 312	146 400
	32	42.4 x 2.0	63	19.5	4.5	6	146 316	–
			80	19.5	5.0	14	146 324	146 408
	40	48.3 x 2.0	80	31.0	5.0	9	146 329	–
			125	31.0	3.2	16	146 341	146 416
	50	60.3 x 2.0	100	45.0	4.4	7.2	146 347	–
			125	45.0	3.2	10	146 359	146 424
	65	76.1 x 2.3	125	73.0	5.6	12	152 748	156 478
175			73.0	4.5	15	152 766	–	
80	88.9 x 2.3	125	110.0	5.6	7.5	155 542	156 486	
		175	110.0	4.5	10	152 784	–	
		225	110.0	3.3	12.5	152 802	–	
100	114.3 x 2.6	125	165.0	5.6	5	155 551	156 494	
		175	155.0	4.5	7.0	152 820	–	
		225	155.0	4.8	10	152 838	–	
<p>2/2-way valve, NO by spring action</p>	10	17.2 x 1.6	40	4.7	see charts page 3	16	146 234	146 368
			50	4.7		16	146 244	146 376
	15	21.3 x 1.6	40	4.7	16	146 255	–	
			50	4.7	16	146 267	146 384	
	20	26.9 x 1.6	40	8.1	16	146 279	–	
			50	8.1	16	146 291	146 388	
	25	33.7 x 2.0	63	13.0	16	146 307	146 396	
	32	42.4 x 2.0	63	19.5	16	146 320	146 404	
	40	48.3 x 2.0	80	31.0	16	146 335	146 412	
	50	60.3 x 2.0	100	45.0	16	146 353	146 420	
	65	76.1 x 2.3	125	73.0	15	152 757	156 482	
	80	88.9 x 2.3	125	110.0	12.5	152 775	156 490	
	100	114.3 x 2.6	125	165.0	9	152 811	156 498	
			175	155.0	10	152 829	–	

Further versions on request



Port connections
Weld end O.D.
Clamp



Control function
I (double-acting actuator)



Approvals
GL, EC Gas Appliances Directive (previously DVGW), SIL



Mediums temperature
Valves for mediums temperature up to +200°C or down to -40°C

Ordering chart for valves with flow direction below the seat (other versions on request), cont.

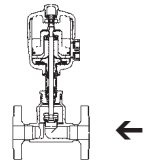

Valves with stainless steel body and weld end according to DIN 11850 Series 2, flow below seat

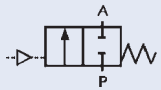
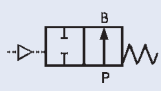
Control function	Orifice [mm]	Weld end DIN 11850 S2 external Ø x Ws [mm]	Actuator size Ø [mm]	Kv value water [m³/h]	Minimum pilot pressure [bar]	Operating pressure up to + 180 °C [bar]	Item no. PA actuator	Item no. PPS actuator
A  2/2-way valve, NC by spring action	10	13 x 1.5	40	4.7	4.0	15	146 230	146 365
			50	4.7	3.9	16	146 240	146 373
	15	19 x 1.5	40	4.7	4.0	15	146 250	-
			50	4.7	3.9	16	146 262	146 381
	20	23 x 1.5	40	8.1	4.0	6.5	146 274	-
			50	8.1	3.9	11	146 286	-
			63	8.1	4.5	16	146 298	146 393
	25	29 x 1.5	63	13.0	4.5	11	146 302	-
			80	13.0	5.0	16	146 313	146 401
	32	35 x 1.5	63	19.5	4.5	6	146 317	-
			80	19.5	5.0	14	146 325	146 409
	40	41 x 1.5	80	31.0	5.0	9	146 330	-
			125	31.0	3.2	16	146 342	146 417
	50	53 x 1.5	100	45.0	4.4	7.2	146 348	-
			125	45.0	3.2	10	146 360	146 425
	65	70.0 x 2.0	125	73.0	5.6	12	152 749	156 479
175			73.0	4.5	15	152 767	-	
80	85.0 x 2.0	125	110.0	5.6	7.5	155 543	156 487	
		175	110.0	4.5	10	152 785	-	
		225	110.0	3.3	12.5	152 803	-	
100	104.0 x 2.0	125	165.0	5.6	5	155 552	156 495	
		175	155.0	4.5	7.0	152 821	-	
		225	155.0	4.8	10	152 839	-	
B  2/2-way valve, NO by spring action	10	13 x 1.5	40	4.7	see charts page 3	16	146 235	146 369
			50	4.7		16	146 245	146 377
	15	19 x 1.5	40	4.7	16	146 256	-	
			50	4.7	16	146 268	146 385	
	20	23 x 1.5	40	8.1	16	146 280	-	
			50	8.1	16	146 292	146 389	
	25	29 x 1.5	63	13.0	16	146 308	146 397	
	32	35 x 1.5	63	19.5	16	146 321	146 405	
	40	41 x 1.5	80	31.0	16	146 336	146 413	
	50	53 x 1.5	100	45.0	16	146 354	146 421	
	65	70.0 x 2.0	125	73.0	15	152 758	156 483	
	80	85.0 x 2.0	125	110.0	12.5	152 776	156 491	
	100	104.0 x 2.0	125	165.0	9	152 812	156 499	
			175	155.0	10	152 830	-	

DTS 1000010970 EN Version: T validé printed: 04.08.2014 Status: RL (released | freigegeben |

i Further versions on request

 **Port connections**
 Weld end O.D.
 Clamp

 **Control function**
 I (double-acting actuator)

 **Approvals**
 GL, EC Gas Appliances Directive (previously DVGW), SIL

 **Mediums temperature**
 Valves for mediums temperature up to +200°C or down to -40°C

Technical data for valves with flow direction above the seat

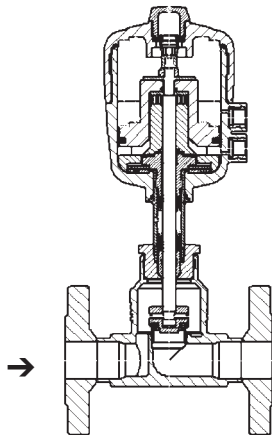

Flow direction above seat

Type 2012 with flange connection

Technical data	Flow direction above the seat
Medium	Gaseous medium and steam
Other technical data	Please see technical data for flow direction below seat

Orifice [mm]	Actuator size [mm]	Kv value water [m³/h]	Operating pressure up to +180° [bar]	Weight with flange [kg]	Threaded port and weld end [kg]
10	40	3.0	16	2.3	0.8
	50	3.0	16	2.4	0.9
15	40	4.7	16	2.3	0.8
	50	4.7	16	2.4	0.9
20	40	8.1	16	3.1	0.9
	50	8.1	16	3.3	1.1
25	50	13.0	16	4.0	1.4
32	63	19.5	16	6.6	2.9
40	80	31.0	16	8.4	4.2
50	80	45.0	16	11.4	5.6
65	125	73.0	10	20.2	12.9
80	125	110.0	10	24.5	16.1
100	125	165.0	6	32.9	20.6

Pressure charts

DN 10-20

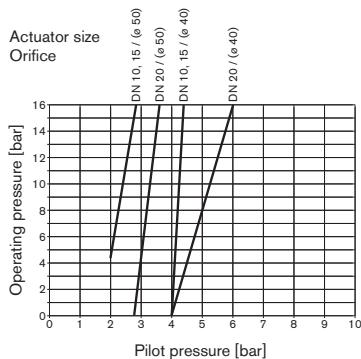

DN 25-50

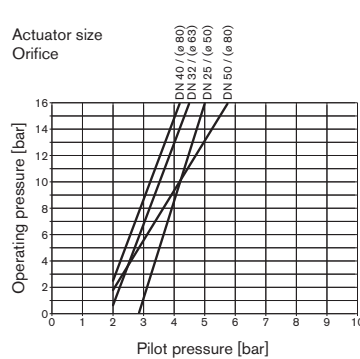

DN 65-100

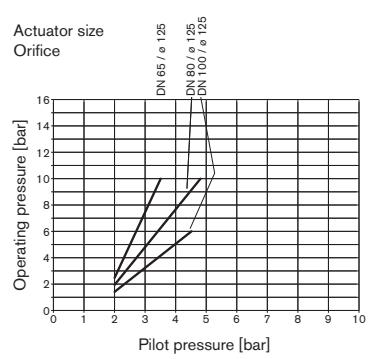

Ordering chart valves with flow direction above the seat (other versions on request)

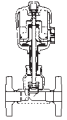

Valves with stainless steel body and flange connection according to DIN EN 1092-1, flow above seat

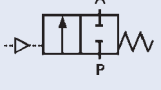
Control function	Orifice [mm]	Connection	Actuator size Ø [mm]	Kv value water [m ³ /h]	Minimum pilot pressure [bar]	Operating pressure up to +180 °C [bar]	Item no. PA actuator	Item no. PPS actuator
A  2/2-way valve, NC by spring action	10	Flange	40	4.7	see charts page 8	16	146 427	–
		Flange	50	4.7		16	146 432	146 492
	15	Flange	40	4.7		16	146 437	–
		Flange	50	4.7		16	146 443	146 496
	20	Flange	40	8.1		16	146 448	–
		Flange	50	8.1		16	146 454	146 500
	25	Flange	50	13.0		16	146 460	146 504
	32	Flange	63	19.5		16	146 465	146 508
	40	Flange	80	31.0		16	146 476	146 512
	50	Flange	80	45.0		16	146 487	146 516
	65	Flange	125	73.0		10	152 842	–
	80	Flange	125	110.0		10	152 851	–
100	Flange	125	165.0	6	152 860	–		

Valves with stainless steel body and threaded port connection, flow above seat

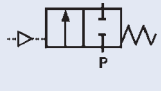
Control function	Orifice [mm]	Connection	Actuator size Ø [mm]	Kv value water [m ³ /h]	Minimum pilot pressure [bar]	Operating pressure up to +180 °C [bar]	Item no. PA actuator	Item no. PPS actuator
A  2/2-way valve, NC by spring action	10	G 3/8	40	4.7	see charts page 8	16	146 428	–
			50	4.7		16	146 433	146 493
	15	G 1/2	40	4.7		16	146 438	–
			50	4.7		16	146 444	146 497
	20	G 3/4	40	8.1		16	146 449	–
			50	8.1		16	146 455	146 501
	25	G 1	50	13.0		16	146 461	146 505
	32	G 1/4	63	19.5		16	146 466	146 509
	40	G 1 1/2	80	31.0		16	146 477	146 513
	50	G 2	80	45.0		16	146 488	146 517
	65	G 2 1/2	125	65.0		10	152 844	–

Attention!

Valves with flow direction above the seat are only conditionally usable for liquid media.

Waterhammer will occur! For flange and threaded port connections pilot pressures, please refer to Charts on page 8.

i Further versions on request**Port connections**Flange acc. to ANSI, JIS
Threaded port NPT, Rc
Clamp**Control function**

I (double-acting actuator) and B (spring-return normally-open)

**Approvals**

GL, EC Gas Appliances Directive (previously DVGW), SIL

**Mediums temperature**

Valves for mediums temperature up to +200°C or down to -40°C

Ordering chart valves with flow direction above the seat (other versions on request), cont.

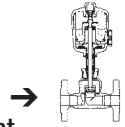

Valves with stainless steel body and weld end according to EN ISO 1127/ISO 4200, flow above seat

Control function	Orifice [mm]	Weld end external Ø x Ws [mm]	Actuator size Ø [mm]	Kv value water [m³/h]	Minimum pilot pressure [bar]	Operating pressure up to +180 °C [bar]	Item no. PA actuator	Item no. PPS actuator
A 2/2-way valve, NC by spring action	10	17.2 x 1.6	40	4.7	see charts page 8	16	146 429	–
			50	4.7		16	146 434	146 494
	15	21.3 x 1.6	40	4.7		16	146 439	–
			50	4.7		16	146 445	146 498
	20	26.9 x 1.6	40	8.1		16	146 450	–
			50	8.1		16	146 456	146 502
	25	33.7 x 2.0	50	13.0		16	146 462	146 506
	32	42.4 x 2.0	63	19.5		16	146 467	146 510
	40	48.3 x 2.0	80	31.0		16	146 478	146 514
	50	60.3 x 2.0	80	45.0		16	146 489	146 518
65	76.1 x 2.3	125	73.0	10	152 847	–		
80	88.9 x 2.3	125	110.0	10	152 856	–		
100	114.3 x 2.6	125	165.0	6	152 865	–		

Valves with stainless steel body and weld end according to DIN 11850 Series 2, flow above seat

Control function	Orifice [mm]	Weld end external Ø x Ws [mm]	Actuator size Ø [mm]	Kv value water [m³/h]	Minimum pilot pressure [bar]	Operating pressure up to +180 °C [bar]	Item no. PA actuator	Item no. PPS actuator
A 2/2-way valve, NC by spring action	10	13 x 1.5	40	4.7	see charts page 8	16	146 430	–
			50	4.7		16	146 435	146 495
	15	19 x 1.5	40	4.7		16	146 440	–
			50	4.7		16	146 446	146 499
	20	23 x 1.5	40	8.1		16	146 451	–
			50	8.1		16	146 457	146 503
	25	29 x 1.5	50	13.0		16	146 463	146 507
	32	35 x 1.5	63	19.5		16	146 468	146 511
	40	41 x 1.5	80	31.0		16	146 479	146 515
	50	53 x 1.5	80	45.0		16	146 490	146 519
65	70.0 x 2.0	125	73.0	10	152 848	–		
80	85.0 x 2.0	125	110.0	10	152 857	–		
100	104.0 x 2.0	125	165.0	6	152 866	–		

Attention!

Valves with flow direction above the seat are only conditionally usable for liquid media. Waterhammer will occur! For weld ends according to EN ISO 1127/ISO 4200 and DIN 11850 Series 2 pilot pressures, please refer to Charts page 8.

i Further versions on request

Port connections
Weld end, O.D.
Clamp



Control function
I (double-acting actuator) and B (spring-return normally-open)



Approvals
GL, EC Gas Appliances Directive (previously DVGW), SIL



Mediums temperature
Valves for mediums temperature up to +200°C or down to -40°C

Ordering chart for accessories

3/2-way pilot valves with banjo bolts

Seal material valve FKM, seal material banjo bolt NBR

Valve for actuator size [Ø mm]	Type	Pressure inlet P (valve body)	Service port A (banjo bolt)	Orifice [mm]	Qn value air [l/min]	Pressure range [bar]	Electrical coil connection Ind. Std.	Power consumption [W]	Item no. Voltage/frequency [V/Hz]	
									024/DC	230/50
40	6012P	Tube fitting ø6 mm	G 1/8	1.2	48	0-10	Form B	4	552 287	552 290
40	6012P	G 1/8	G 1/8	1.2	48	0-10	Form B	4	552 299	552 302
40	6012P	G 1/4	G 1/8	1.2	48	0-10	Form B	4	552 295	552 298
50-63	6012P	Tube fitting ø6 mm	G 1/4	1.2	48	0-10	Form B	4	552 283	552 286
50-125	6014P	G 1/4	G 1/4	2	120	0-10	Form A	8	424 103	424 107
175-225	6014P	G 1/8	G 1/4	2.5	174	0-6	Form A	8	786 014	786 015
175-225	0331P	G 1/4	G 1/4	3	194	0-10	Form A	8	–	041 233

Cable plug Type 2507, Form B or Type 2508, Form A

	Item no.
Type 2507, Form B Industrial standard, 0 to 250 V without circuitry (Type 6012 P)	423 845
Type 2508, Form A acc. DIN EN 175301-803, 0 to 250 V without circuitry (Type 6014 P, Type 0331P)	008 376

For further accessories see Type 1062, or the accessories datasheet Type 2XXX for the full options programme.

Note: For design reasons, some of the accessories cannot be supplied for actuator size Ø 40, 175 and 225 mm. Please request the accessories datasheet Type 2XXX.

Dimensions [mm]

DN 10-50
With threaded
port connection

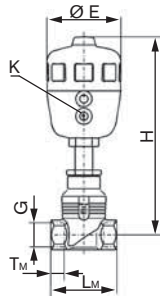

DN 10-50
With weld end acc. to
EN ISO 1127/ISO 4200 or
DIN 11850 Series 2

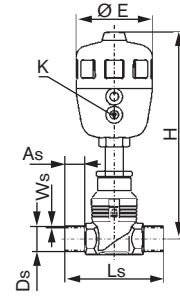

All bodies					Threaded port body			Weld end bodies EN ISO 1127/ISO 4200				Weld end bodies DIN11850 Series 2			
DN	Actuator size Ø	E Ø	H	K	G	LM	TM	As	Ds	Ls	Ws	As	Ds	Ls	Ws
10	40	53	168	G 1/8	G 3/8	65	12	20	17.2	90	1.6	20	13	90	1.5
	50	64	211	G 1/4											
15	40	53	168	G 1/8	G 1/2	65	14	20	21.3	90	1.6	20	19	90	1.5
	50	64	211	G 1/4											
20	40	53	170	G 1/8	G 3/4	75	16	20	26.9	100	1.6	20	23	100	1.5
	50	64	213	G 1/4											
	63	80	247												
25	50	64	220	G 1/4	G 1	90	18	26	33.7	130	2.0	26	29	130	1.5
	63	80	251												
	80	101	273												
32	63	80	271	G 1/4	G 1 1/4	110	20	26	42.4	140	2.0	26	35	140	1.5
	80	101	294												
40	80	101	299	G 1/4	G 1 1/2	120	22	26	48.3	150	2.0	26	41	150	1.5
	100	127	366												
	125	157	397												
50	80	101	309	G 1/4	G 2	150	24	26	60.3	175	2.0	26	53	175	1.5
	100	127	370												
	125	153	402												

DN 65-100
With threaded port
connection

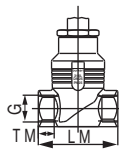

DN 65-100
With weld end acc. to
EN ISO 1127/ISO 4200 or
DIN 11850 Series 2

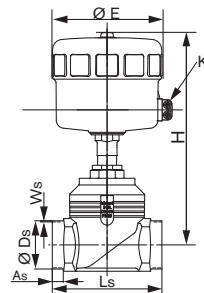

All bodies					Threaded port body			Weld end bodies EN ISO 1127/ISO 4200				Weld end bodies DIN11850 Series 2			
DN	Actuator size Ø	E Ø	H	K	G	LM	TM	As	Ds	Ls	Ws	As	Ds	Ls	Ws
65	125	157	430	G 1/4	G 2 1/2	185	26	26	76.1	210	2.3	26	70	210	2
	175	211	491												
80	125	157	440	G 1/4	-	-	-	26	88.9	230	2.3	26	85	230	2
	175	211	498												
	225	261	494												
100	125	157	450	G 1/4	-	-	-	26	114.3	260	2.6	26	104	260	2
	175	211	508												
	225	261	504												

Dimensions [mm], cont.

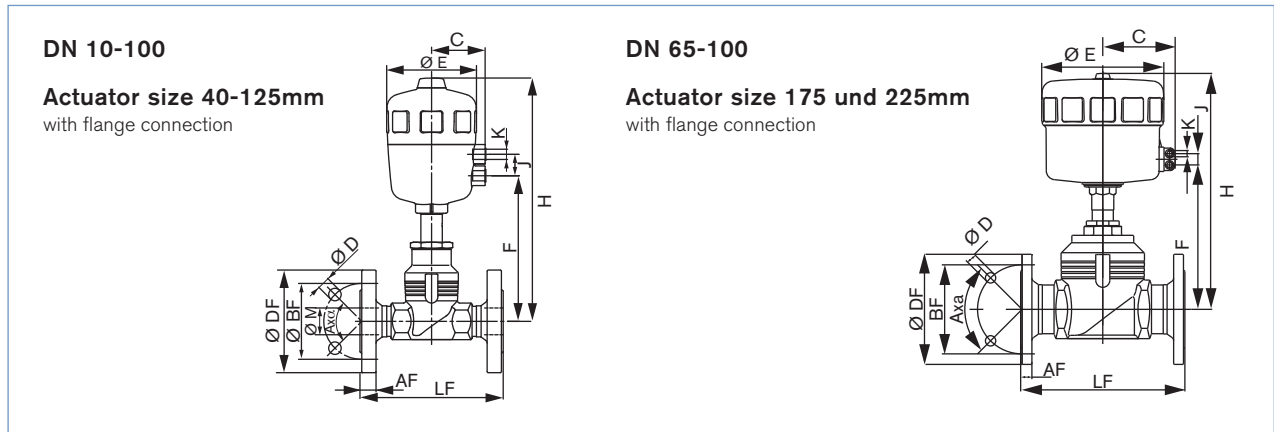

All bodies								DIN flange						JIS flange								
DN	Actuator	C	ØE	F	H	K	J	ØDF	LF	ØBF	AF	ØD	AxD	ØM	ØDF	LF	ØBF	AF	ØD	AxD	ØM	
10	40	33	53	116	168	G1/8	16.5	90	130	60	16	14	4x90°	14	-	-	-	-	-	-	-	-
	50	44	64	131	211	G1/4	24	90	130	60	16	14	4x90°	14	-	-	-	-	-	-	-	-
15	40	33	53	116	168	G1/8	16.5	95	130	65	16	14	4x90°	18	95	108	70	12	15	4x90°	18	
	50	44	64	131	211	G1/4	24	95	130	65	16	14	4x90°	18	95	108	70	12	15	4x90°	18	
20	40	33	53	118	170	G1/8	16.5	105	150	75	18	14	4x90°	24	100	117	75	14	15	4x90°	24	
	50	44	64	135	213	G1/4	24	105	150	75	18	14	4x90°	24	100	117	75	14	15	4x90°	24	
	63	52	80	155	247	G1/4	24	105	150	75	18	14	4x90°	24	100	117	75	14	15	4x90°	24	
25	50	44	64	140	220	G1/4	24	115	160	85	18	14	4x90°	30	125	127	90	14	19	4x90°	30	
	63	52	80	159	251	G1/4	24	115	160	85	18	14	4x90°	30	125	127	90	14	19	4x90°	30	
	80	60	101	164	273	G1/4	24	115	160	85	18	14	4x90°	30	125	127	90	14	19	4x90°	30	
32	63	52	80	179	271	G1/4	24	140	180	100	18	18	4x90°	38	135	140	100	16	19	4x90°	38	
	80	60	101	184	294	G1/4	24	140	180	100	18	18	4x90°	38	135	140	100	16	19	4x90°	38	
40	63	52	80	184	276	G1/4	24	150	200	110	18	18	4x90°	44	140	165	105	16	19	4x90°	44	
	80	60	101	189	299	G1/4	24	150	200	110	18	18	4x90°	44	140	165	105	16	19	4x90°	44	
	100	73	127	214	366	G1/4	30	150	200	110	18	18	4x90°	44	140	165	105	16	19	4x90°	44	
	125	86	157	220	397	G1/4	30	150	200	110	18	18	4x90°	44	140	165	105	16	19	4x90°	44	
50	63	52	80	195	287	G1/4	24	165	230	125	20	18	4x90°	56	155	203	120	16	19	4x90°	56	
	80	60	101	199	309	G1/4	24	165	230	125	20	18	4x90°	56	155	203	120	16	19	4x90°	56	
	100	73	127	218	370	G1/4	30	165	230	125	20	18	4x90°	56	155	203	120	16	19	4x90°	56	
	125	86	157	225	402	G1/4	30	165	230	125	20	18	4x90°	56	155	203	120	16	19	4x90°	56	
65	125	86	157	254	430	G1/4	30	185	290	145	22	18	8x45°	66	175	216	140	18	19	4x90°	72	
	175	130	211	289	491	G1/4	24	185	290	145	22	18	8x45°	66	175	216	140	18	19	4x90°	72	
80	125	86	157	264	440	G1/4	30	200	310	160	24	18	8x45°	81	185	241	150	18	19	8x45°	84	
	175	130	211	296	498	G1/4	24	200	310	160	24	18	8x45°	81	185	241	150	18	19	8x45°	84	
	225	155	261	299	494	G1/4	24	200	310	160	24	18	8x45°	81	185	241	150	18	19	8x45°	84	
100	125	86	157	274	450	G1/4	30	235	350	190	24	22	8x45°	100	210	292	175	18	19	8x45°	109	
	175	130	211	306	508	G1/4	24	235	350	190	24	22	8x45°	100	210	292	175	18	19	8x45°	109	
	225	155	261	309	504	G1/4	24	235	350	190	24	22	8x45°	100	210	292	175	18	19	8x45°	109	

Dimensions [mm], cont.

All bodies								ANSI flange							
DN	Actuator	C	ØE	F	H	K	J	ØDF	LF	ØBF	AF	ØD	AxD	ØM	
1/2"	40	33	53	116	168	G1/8	16.5	89	184	60.5	11.2	15.7	4x90°	16	
	50	44	64	131	211	G1/4	24	89	184	60.5	11.2	15.7	4x90°	16	
3/4"	40	33	53	118	170	G1/8	16.5	99	184	69.9	12.7	15.7	4x90°	21	
	50	44	64	135	213	G1/4	24	99	184	69.9	12.7	15.7	4x90°	21	
	63	52	80	155	247	G1/4	24	99	184	69.9	12.7	15.7	4x90°	21	
1"	50	44	64	140	220	G1/4	24	108	184	79.2	14.2	15.7	4x90°	27	
	63	52	80	159	251	G1/4	24	108	184	79.2	14.2	15.7	4x90°	27	
	80	60	101	164	273	G1/4	24	108	184	79.2	14.2	15.7	4x90°	27	
1 1/2"	63	52	80	184	276	G1/4	24	127	222	98.6	17.5	15.7	4x90°	41	
	80	60	101	189	299	G1/4	24	127	222	98.6	17.5	15.7	4x90°	41	
	100	73	127	214	366	G1/4	30	127	222	98.6	17.5	15.7	4x90°	41	
	125	86	157	220	397	G1/4	30	127	222	98.6	17.5	15.7	4x90°	41	
2"	63	52	80	195	287	G1/4	24	152	254	120.7	19.1	19.1	4x90°	53	
	80	60	101	199	309	G1/4	24	152	254	120.7	19.1	19.1	4x90°	53	
	100	73	127	218	370	G1/4	30	152	254	120.7	19.1	19.1	4x90°	53	
	125	86	157	225	402	G1/4	30	152	254	120.7	19.1	19.1	4x90°	53	
2 1/2"	125	86	157	254	430	G1/4	30	178	276	139.7	22.3	19.1	4x90°	63	
	175	130	211	289	491	G1/4	24	178	276	139.7	22.3	19.1	4x90°	63	
3"	125	86	157	264	440	G1/4	30	190	298	152.4	23.9	19.1	4x90°	78	
	175	130	211	296	498	G1/4	24	190	298	152.4	23.9	19.1	4x90°	78	
	225	155	261	299	494	G1/4	24	190	298	152.4	23.9	19.1	4x90°	78	
4"	125	86	157	274	450	G1/4	30	229	352	190.5	23.9	19.1	8x45°	102	
	175	130	211	306	508	G1/4	24	229	352	190.5	23.9	19.1	8x45°	102	
	225	155	261	309	504	G1/4	24	229	352	190.5	23.9	19.1	8x45°	102	

Ordering information for valve system On/Off Classic Type 8801-GA/8803-GA

A valve system On/Off Classic Type 8801-GA/8803-GA consists of an globe valve Type 2012 and a valve actuation system control head Type 8691, a pneumatic control unit Type 8690 or an electrical position feedback Type 1062 (see separate datasheets).

For the configuration of further valve systems please use the "Request for quotation" on p. 19 [go to page](#)

You order two components and receive a complete assembled and certified valve.

Ordering the valve system On/Off Classic Type 8801-GA/8803-GA

Globe valve Type 2012 with required port connection



Control units



Globe valve with desired control unit



When you click on the orange box "More info." below, you will come to our website for the resp. product where you can download the datasheet.

Control head Type 8691



More info.

The new generation of integrated control heads for combination with actuators from the process valve series Type 20xx/21xx is specially designed for the requirements of hygienic process environments. The intelligent control head, Type 8691, detects the valve position by means of a contact-free analog position sensor circumventing excessive wear of mechanical parts. Single or double-acting actuators are controlled via the integral pilot valve. Communication interfaces AS-Interface and DeviceNet are available as options.

Main customer benefits:

- Automatic setting of the control head at the push of a button
- Even under dirty or dark environments, a clearly visible status display due to powerful LEDs
- Monitoring and diagnosis: Process valve systems with field bus interface used in modern plant processes
- Integrated pilot valve with manual actuation
- Air intake filter enhances the process valve system availability
- Simple and reliable actuator adaptations allowing additional actuators of the process valve series, Type 20xx or actuators from other manufacturers to be used

Pneumatic control unit Type 8690



More info.

The new generation of integrated controllers for combination with actuators from the process valve series Type 20xx/21xx is specially designed for the requirements of hygienic process environments.

The pneumatic control unit Type 8690 combines electrical position feedback and pneumatic control for single or double-acting actuators, and is also optionally available as an intrinsically safe model to ATEX.

Main customer benefits:

- Integrated pilot valve with manual actuation
- Air intake filter enhances the process valve system availability
- Simple and reliable actuator adaptations allowing additional actuators of the process valve series, Type 20xx or actuators from other manufacturers to be used

Electrical position feedback Type 1062



More info.

Positions are electrically signalized according to switch type:

- open,
- closed or
- open and closed.

LEDs provide optical position indication (except for Namur Ex-version). Mechanical or inductive switches are housed in a compact splash-proof enclosure. The position indicator can be rotated 360° and is easily fitted to the valve. Trip cams do not require adjustment. The unit only needs to be screwed on and connected to be ready for operation.

Dimensions for valve system On/Off Classic Type 8801-GA-H [mm]

Dimensions valve system On/Off Classic Type 8801-GA-H with control head Type 8691

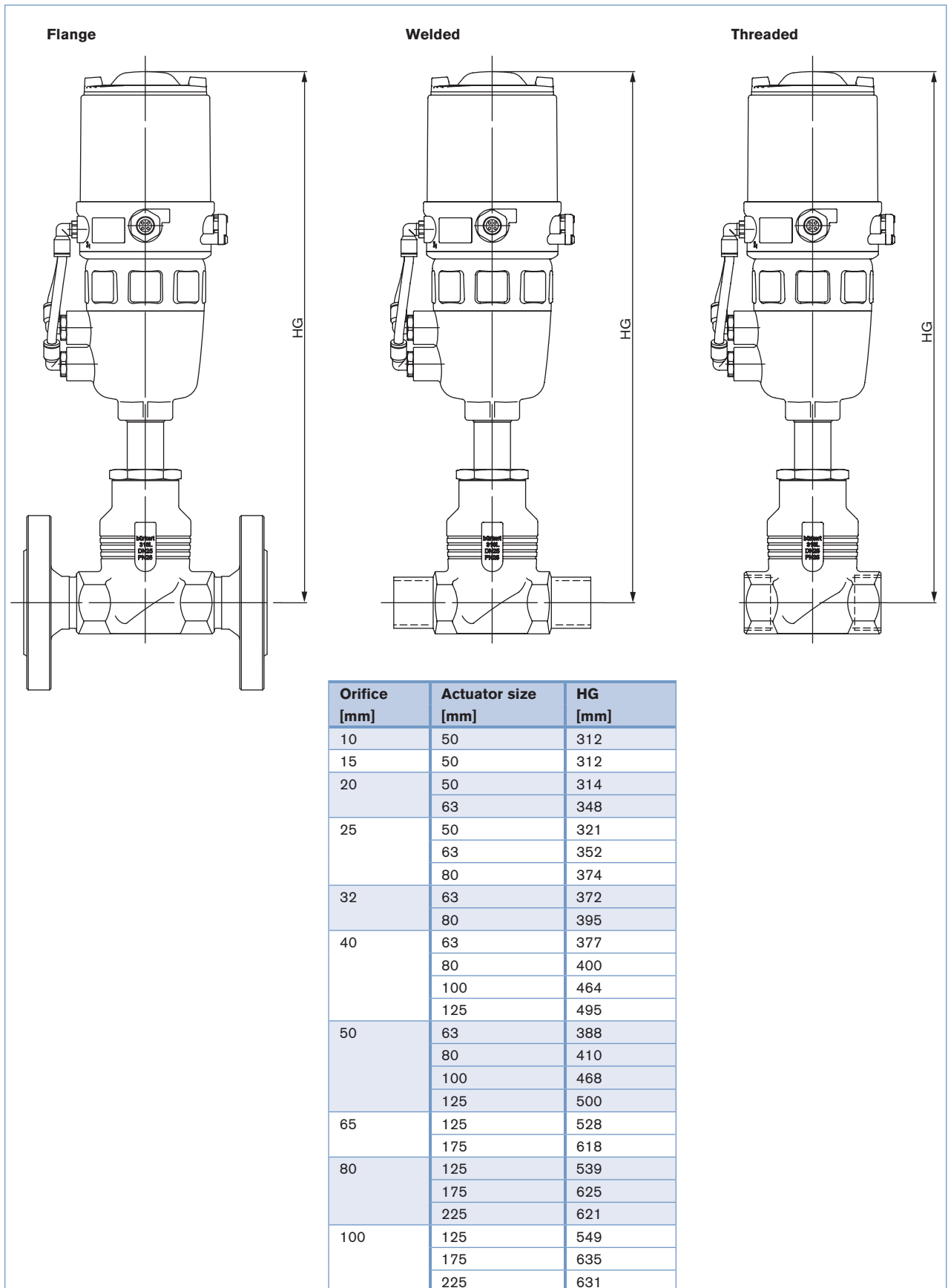

Dimensions for valve system On/Off Classic Type 8801-GA-K [mm]

Dimensions valve system On/Off Classic Type 8801-GA-K with pneumatic control unit Type 8690

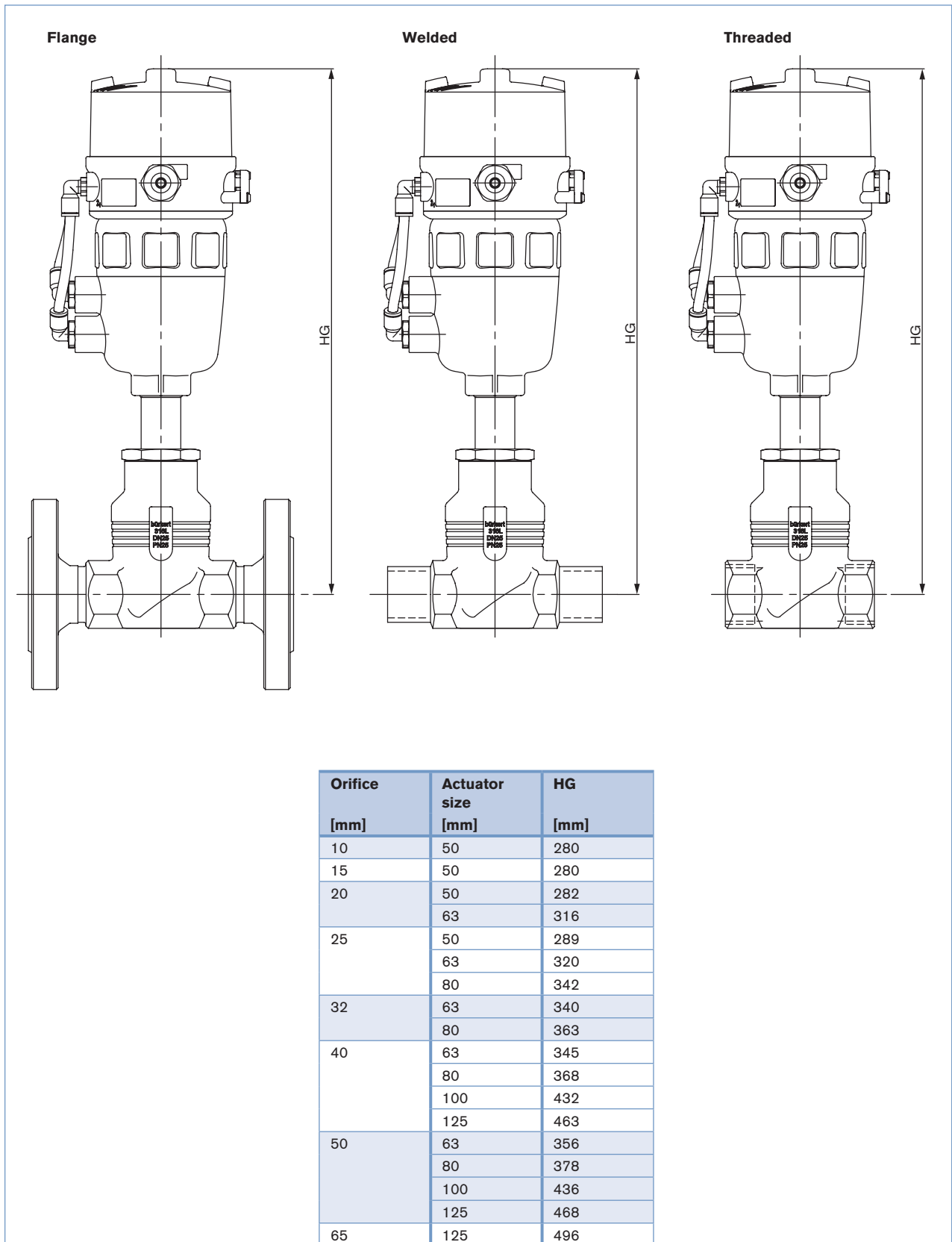

Dimensions for valve system On/Off Classic Type 8803-GA [mm]

Dimensions valve system On/Off Classic Type 8803-GA with electrical position feedback Type 1062

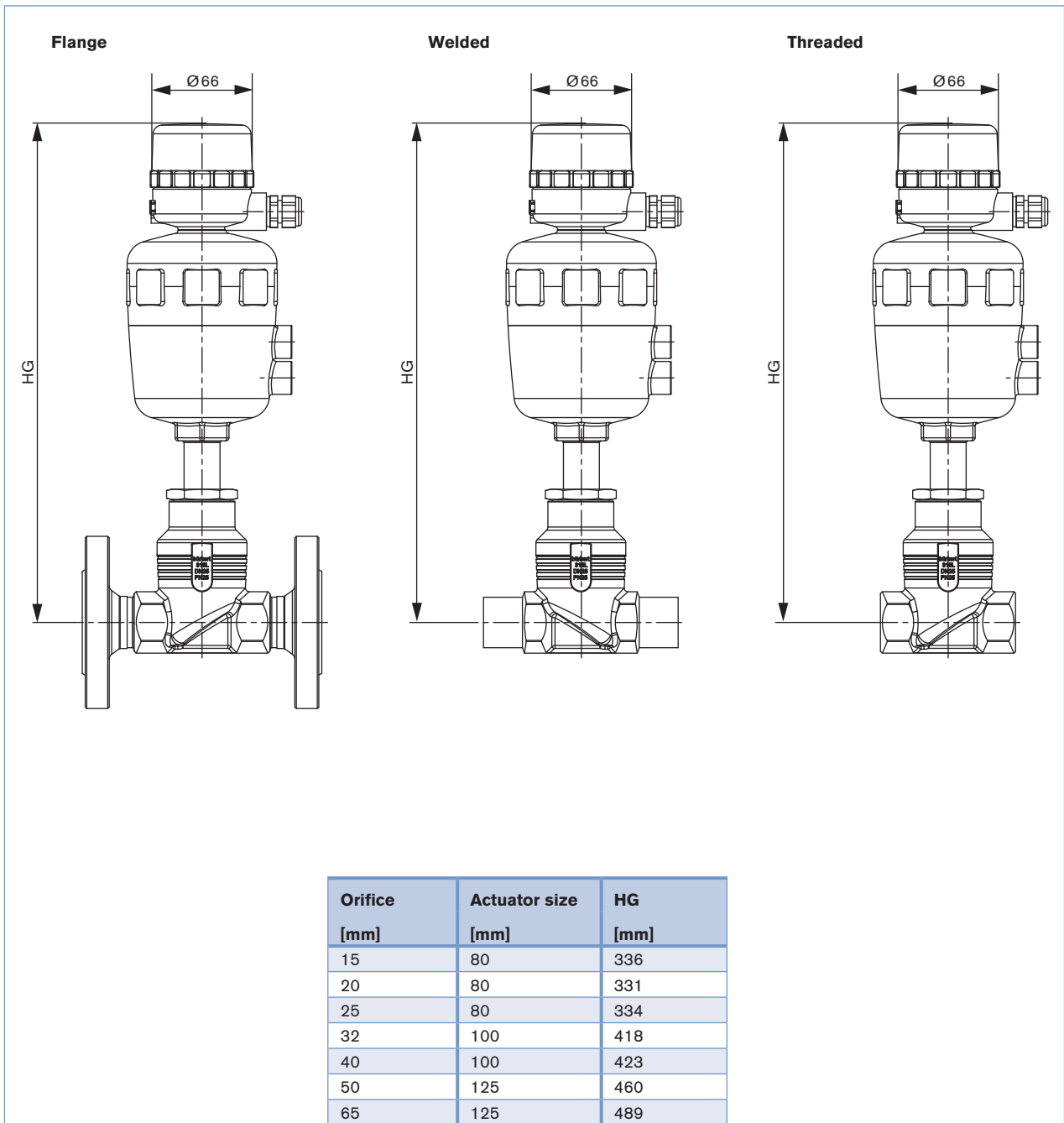

Note

You can fill out the fields directly in the PDF file before printing out the form.

Valve system On/Off Classic Type 8801-GA/8803-GA – request for quotation

Please fill out and send to your nearest Bürkert facility* with your inquiry or order

Company	Contact person
Customer no.	Department
Address	Tel./Fax
Postcode/town	E-Mail

= mandatory fields to fill out Quantity Required delivery date

Operating data

Pipeline	DN	<input type="text"/>	PN	<input type="text"/>
Pipe material	<input type="text"/>			
Process medium	<input type="text"/>			
Type of medium	<input type="checkbox"/> Liquid	<input type="checkbox"/> Steam	<input type="checkbox"/> Gas	
	standard	unit		
Flow rate (Q, Q _N , W) ¹⁾	<input type="text"/>	<input type="text"/>		
Temperature at valve inlet	<input type="text"/>			
Absolute pressure at valve inlet	<input type="text"/>			

¹⁾ standard unit: Liquid Q = m³/h; Steam W = kg/h; Gas Q_N = Nm³/h

Valve features

Actuator material	<input type="checkbox"/> PA	<input type="checkbox"/> PPS	
Body material	<input type="checkbox"/> Stainless steel	<input type="checkbox"/> Gunmetal	
Seat sealing material	<input type="checkbox"/> PTFE <input type="checkbox"/> NBR	<input type="checkbox"/> Other <input type="text"/>	
Nominal pressure	PN	<input type="text"/>	
Nominal size	DN	<input type="text"/>	
Type of connection	<input type="checkbox"/> Welded	<input type="checkbox"/> Internal thread	<input type="checkbox"/> Clamp
Standard connection	<input type="checkbox"/> ISO	<input type="checkbox"/> DIN	<input type="checkbox"/> ANSI <input type="checkbox"/> JIS <input type="checkbox"/> Other <input type="text"/>
Function	<input type="checkbox"/> NC ²⁾	<input type="checkbox"/> NO ²⁾	<input type="checkbox"/> Double-acting
Pilot pressure	<input type="text"/>	min.	<input type="text"/>
			max.

²⁾ NC: normally closed by spring action; NO: normally open by spring action

Control unit features

Click on the orange box "More info." below... you will come to our website for the resp. product where you can download the datasheet.

Control Head	Pneumatic Control Unit	Electrical position feedback
<input type="checkbox"/> Type 8691 More info.	<input type="checkbox"/> Type 8690 More info.	<input type="checkbox"/> Type 1062 More info.
Pneumatic function <input type="checkbox"/> Single-acting <input type="checkbox"/> Double-acting Pilot air ports <input type="checkbox"/> Push-in connector external ø 6 mm or 1/4" <input type="checkbox"/> Thread G 1/8" Communication <input type="checkbox"/> ASI <input type="checkbox"/> Multipol M12 <input type="checkbox"/> Flat cable clip, 1 m cable <input type="checkbox"/> DeviceNet Please specify item no. if known: <input type="text"/>	Pneumatic function <input type="checkbox"/> Single-acting <input type="checkbox"/> Double-acting <input type="checkbox"/> Without pilot valve Position feedback <input type="checkbox"/> 1x inductive <input type="checkbox"/> 2x inductive <input type="checkbox"/> 1x inductive (NAMUR) <input type="checkbox"/> 2x inductive (NAMUR) <input type="checkbox"/> 1x mechanical <input type="checkbox"/> 2x mechanical Supply voltage <input type="checkbox"/> 24 V / DC (ATEX Zone 2/22) <input type="checkbox"/> Ex ia IIC T6 (ATEX Zone 1) Pilot air ports <input type="checkbox"/> Push-in connector <input type="checkbox"/> Thread G 1/8" external ø 6 mm or 1/4" Please specify item no. if known: <input type="text"/>	Limit switches <input type="checkbox"/> mechanical <input type="checkbox"/> Voltage 12-48 V <input type="checkbox"/> Voltage 110-250 V <input type="checkbox"/> inductive <input type="checkbox"/> NAMUR EExi Status <input type="checkbox"/> closed <input type="checkbox"/> open <input type="checkbox"/> open/closed Please specify item no. if known: <input type="text"/>

continued on next page →

Valve system On/Off Classic Type 8801-GA/8803-GA – request for quotation, *continued*

Control unit features	
Pilot valve	Stroke limitation
<input type="checkbox"/> Pilot valve	<input type="checkbox"/> Stroke limitation
Power supply <input type="text"/>	<input type="checkbox"/> Min./max. stroke limitation , with visual position indicator
	<input type="checkbox"/> Max. stroke limitation , without visual position indicator
Please specify item no. if known: <input type="text"/>	Please specify item no. if known: <input type="text"/>

Certifications
<input type="checkbox"/> Attestation of compliance with the order EN-ISO 10204 2.1
<input type="checkbox"/> Test report EN-ISO 10204 2.2
<input type="checkbox"/> Certification of Conformity for Raw Material EN-ISO 10204 3.1
<input type="checkbox"/> EN161 (EC Gas Appliances Directive)

Comment / sketch

DTS 1000010970 EN Version: T validé printed: 04.08.2014 Status: RL (released | freigegeben |

To find your nearest Bürkert facility, click on the orange box → www.burkert.com