

## Guided microwave level measuring device

- Universal level measuring device for liquids and bulk materials
- 4... 20 mA/Hart - 2 wires
- Insensitive to dust and steam
- ATEX approvals 

Type 8185 can be combined with



**Type 8635**

SideControl Ex



**Type 2035**

Diaphragm valve



**Type 8802-GD**

Continuous  
TopControl system

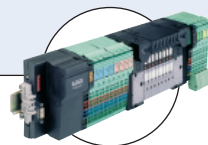

**Type 8644**

Valve islands

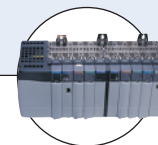

**PLC**

The Type 8185 is a level measuring device with cable or rod probe, designed for continuous level measurement. The unit is suitable for liquids, but also for solids, for industrial use in all areas of process technology. With a measuring range of up to 32 m, the 8185 is best suited for tall vessels. Even process conditions such as strong steam generation, density fluctuations or changes of the dielectric constant do not influence the accuracy of the measurement. Build-up or condensation on the probe or vessel wall do not influence the measuring result.

### General data

#### Materials

Housing / Cover	PBT, Stainless steel 316L / PC
Seal ring / Ground terminal	NBR / Stainless steel 316L
Wetted parts	
Process fitting / process seal	Stainless steel 316L (1.4435) and PCTFE / FKM
Inner conductor	
(up to the separation cable/rod)	Stainless steel 1.4462
Rod-ø 6 mm	Stainless steel 316L (1.4435)
Cable-ø 4 mm with gravity weight	Stainless steel 316 (1.4401)

#### Display

LCD in full dot matrix

#### Weight

Housing	890 g
Rod-ø 6 mm	approx. 220 g/m
Cable-ø 4 mm	approx. 80 g/m
Gravity weight (only with cable version)	approx. 325 g

#### Process fitting

Thread G or NPT - 3/4", 1"

#### Length

Rod-ø 6 mm	0.3... 4 m - Lateral load: 4 Nm
Cable-ø 4 mm	1... 32 m - Max. tensile load: 5 KN

#### Electrical connections

Cable gland M20 x 1.5

#### Measuring type

Level of liquids and solids

#### Min. dielectric figure

$\epsilon_r > 1.6$

#### Dead zone

Rod-ø 6 mm	From top of probe: 80 mm - from bottom of probe: 0 mm
Cable-ø 4 mm	From top of probe: 150 mm - from bottom of probe: 250 mm

#### Measuring range

0.08... 4 m or 0.15... 32 m (see diagram on next page)

#### Process temperature

-40 to 150°C (-40 to 302°F)

#### Process pressure

-1 to 40 bar (-14.51 to 580.1 PSI) (-100... 4000 kPa) (depends on the process fitting)

#### Temperature drift

0.06%/10K (Relating to the max. measuring range)

#### Accuracy

See accuracy diagram, on next page

Electrical data	
<b>Operating voltage</b>	14 - 36 V DC or 14 - 30 V DC (Ex ia instrument)
<b>Lightening power consumption</b>	approx. 80 mW
<b>Permissible residual ripple</b>	< 100 Hz: $U_{ss} < 1$ V 100 Hz... 10 kHz: $U_{ss} < 10$ mV
<b>Output signal</b>	4... 20 mA/HART
<b>Resolution</b>	1.6 $\mu$ A
<b>Fault signal</b>	current output unchanged; 20.5 mA; 22 mA < 3.6 mA (adjustable)
<b>Current limitation</b>	22 mA
<b>Load</b>	see load diagram
<b>Integration time</b> (63% of the input variable)	0... 999 s, adjustable
Environment	
<b>Ambient temperature</b> with display, adjustment elements	-20 to +70°C (-4 to 158°F) (operation and storage)
<b>Relative humidity</b>	Max. 75% (operation), max. 85% (storage); without condensation
Standards and approvals	
<b>Protection</b>	IP66/IP67 with M20 x 1.5 gland mounted and tightened
<b>Overvoltage category</b>	III
<b>Protection class</b>	II
<b>Standard</b>	
EMC	EN61326
Security	EN61010-1
ATEX <sup>1)</sup>	EN50014; EN50020; EN50284
NAMUR	NE 21; NE 43
Specifications Ex	
<b>Ⓢ - Protection</b>	Categories 1/2 G or 2G
<b>Ⓢ - Certification</b>	Ex ia IIC T6
<b>Conformity specifications<sup>1)</sup></b>	
Operating voltage $U_i$	30 V
Short circuit rating $I_i$	131 mA
Power limitation $P_i$	983 mW
Ambient temperature	-20 to +41°C (-4 to 105.8°F) (depend on categories)
Internal capacity $C_i$	negligible
Internal inductivity $L_i$	negligible

1) homologation certificate PTB 07 ATEX 2007 X

Measuring range diagram

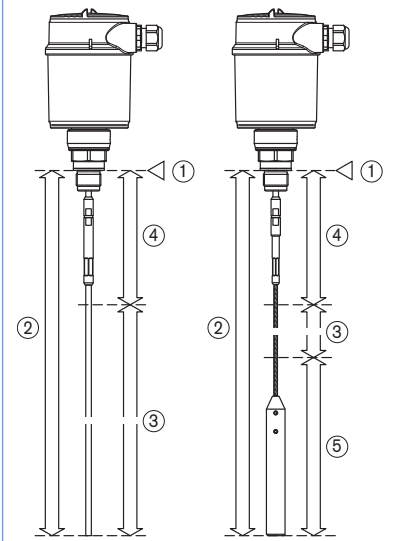

- 1 Reference plane
- 2 Probe length
- 3 Measuring range
- 4 Upper dead band
- 5 Lower dead zone (only with cable versions)

Accuracy diagram

Rod probe version

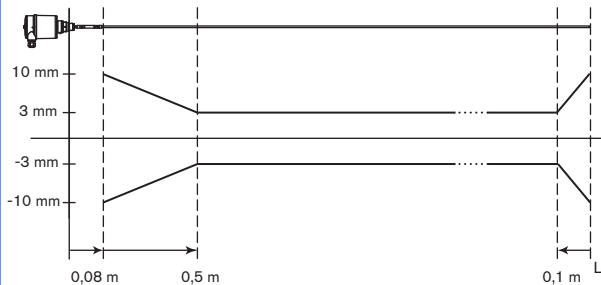

Cable probe version

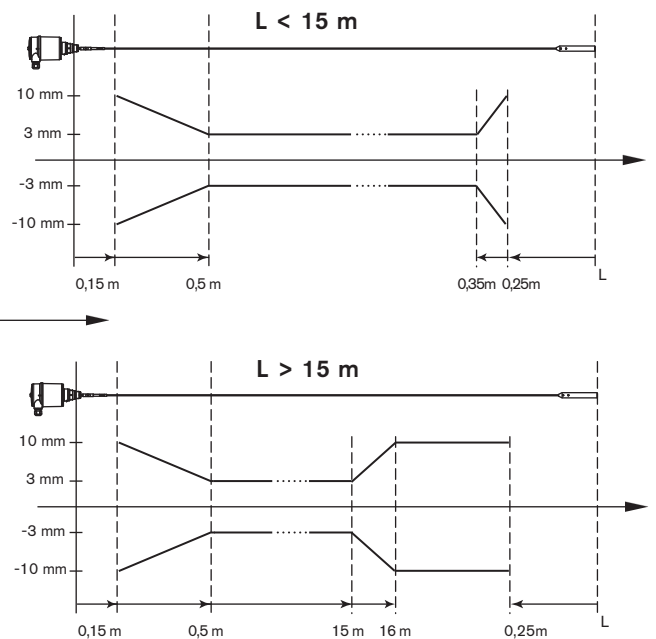

**Load diagram**

- 1 HART load
- 2 Voltage limit Ex ia instrument
- 3 Voltage limit non-Ex instrument
- 4 Operating voltage

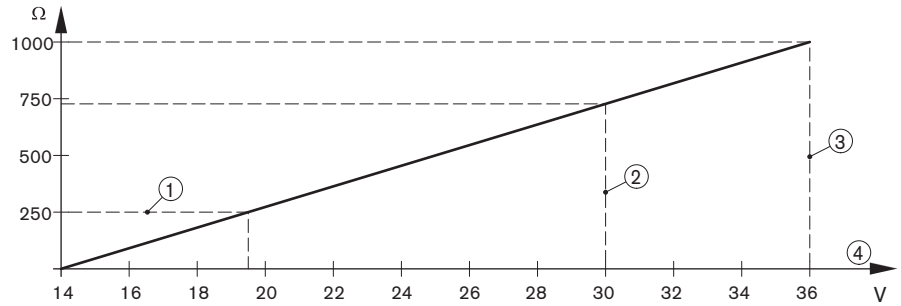
**Target applications with Type 8185****Foodstuffs and animal feed**

Products such as beer, milk, wine, cereals, sugar, flour, coffee, corn-flakes, cacao, instant powder, animal feed - liquids or bulk solids levels must be measured everywhere in the food industry.

The microwave principle works independent of products characteristics such as moisture, intense dust or noise generation, density, temperature, overpressure, foam, dielectric value and the shape of the material cone.

**Chemical industries**

Many finished products in the chemical industry are produced as powder, granules, pellets, solvents... The different and sometimes fluctuating product characteristics place heavy demands on the level measurement.

The measuring result is influenced neither by fluctuating product quality nor by dust generation, density, temperature, overpressure, foam or build-up.

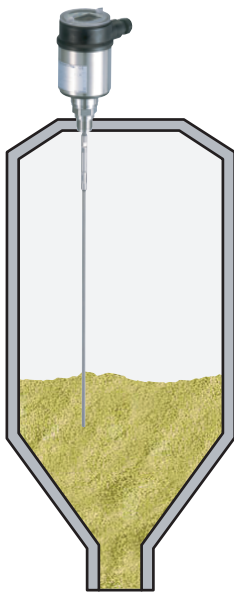
**Application examples**

Level measurement in a grain silo

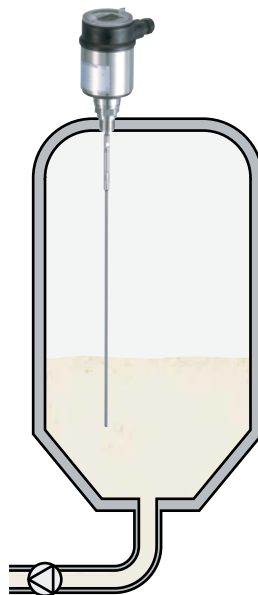

Level measurement in a milk vessel

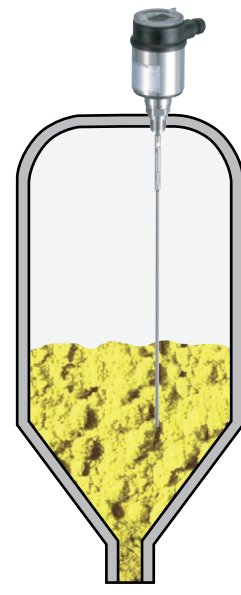

Level measurement of plastic granules

## Principle of operation

High frequency microwave pulses are guided along a steel cable or a rod. When they reach the product surface, the microwave pulses are reflected and received by the processing electronics. The running time is valuated by the instrument and outputted as distance.

Time consuming adjustment with medium is not necessary. The instruments are preset to the ordered probe length.

The shortenable cable and rod versions can be adapted individually to the local requirements.

The measuring device can be adjusted with:

- the display/configuration module
- the suitable Bürkert DTM in conjunction with adjustment software according to the FDT/DTM standard, e.g. PACTware™ and PC.
- a HART handheld

The entered parameters are generally saved in the measuring device Type 8185. Optionally, parameters may also be uploaded and downloaded with the display/configuration module or in PACTware™

### ▶ Set up with display/configuration module

The display/configuration module can be inserted into the measuring device and removed again at any time. It is not necessary to interrupt the power supply. The measuring device is adjusted via the four keys of the display/configuration module

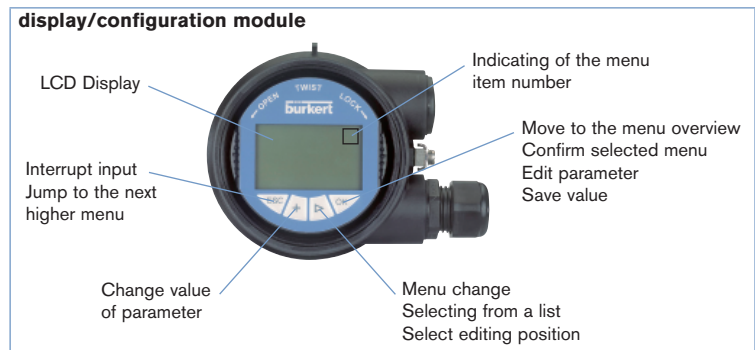

### ▶ Set up with PACTware™/DTM and HART communication

The measuring device can be operated tanks to PACTware™, via the HART signal. An interface adapter is necessary for the adjustment with PACTware™. For the setup of the Type 8185, DTM-Collection in the actual version must be used. The basic version of this DTM Collection incl. PACTware™ is available as a free-of-charge download from the Internet at [www.burkert.com](http://www.burkert.com).

#### Connecting the PC via HART

1. Measuring device 8185
2. HART-USB Modem
3. Resistance 250 Ohm

#### Necessary components:

- Measuring device 8185
- PC with PACTware™ and suitable Bürkert DTM
- HART-USB Modem
- Resistance approx. 250 Ohm
- Power supply unit

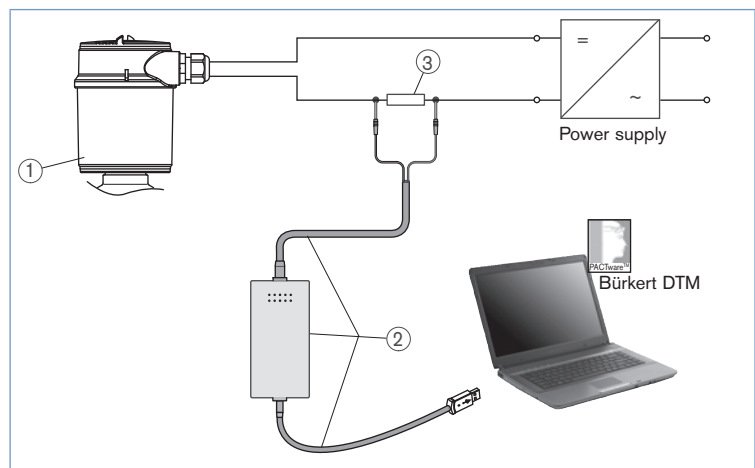



## Ordering chart for compact measuring device Type 8185

Specifications	Voltage supply	Output	Probe	Length	Electrical connection	Item no. with display/ configuration module	Item no. without display/ configuration module
G 3/4" mounting thread	14 - 36 V DC	4 - 20 mA/ HART (2 wires)	Rod	1 m	Cable gland M20 x 1.5	558 229	559 247
				2 m	Cable gland M20 x 1.5	558 233	559 251
			Cable	5 m	Cable gland M20 x 1.5	558 241	559 259
				10 m	Cable gland M20 x 1.5	558 245	559 263
G 1" mounting thread	14 - 36 V DC	4 - 20 mA/ HART (2 wires)	Rod	1 m	Cable gland M20 x 1.5	558 231	559 249
				2 m	Cable gland M20 x 1.5	558 235	559 253
			Cable	5 m	Cable gland M20 x 1.5	558 243	559 261
				10 m	Cable gland M20 x 1.5	558 247	559 265
NPT 3/4" mounting thread	14 - 36 V DC	4 - 20 mA/ HART (2 wires)	Rod	1 m	Cable gland M20 x 1.5	558 230	559 248
				2 m	Cable gland M20 x 1.5	558 234	559 252
			Cable	5 m	Cable gland M20 x 1.5	558 242	559 260
				10 m	Cable gland M20 x 1.5	558 246	559 264
NPT 1" mounting thread	14 - 36 V DC	4 - 20 mA/ HART (2 wires)	Rod	1 m	Cable gland M20 x 1.5	558 232	559 250
				2 m	Cable gland M20 x 1.5	558 236	559 254
			Cable	5 m	Cable gland M20 x 1.5	558 244	559 262
				10 m	Cable gland M20 x 1.5	558 248	559 266
Ex version - ATEX approval G 3/4" mounting thread	14 - 30 V DC	4 - 20 mA/ HART (2 wires)	Rod	1 m	Cable gland M20 x 1.5	558 237	559 255
				2 m	Cable gland M20 x 1.5	558 239	559 257
			Cable	5 m	Cable gland M20 x 1.5	558 249	559 267
				10 m	Cable gland M20 x 1.5	558 251	559 269
Ex version - ATEX approval G 1" mounting thread	14 - 30 V DC	4 - 20 mA/ HART (2 wires)	Rod	1 m	Cable gland M20 x 1.5	558 238	559 256
				2 m	Cable gland M20 x 1.5	558 240	559 258
			Cable	5 m	Cable gland M20 x 1.5	558 250	559 268
				10 m	Cable gland M20 x 1.5	558 252	559 270



## Further versions on request



## Port connection

Thread G or NPT 1"1/2

Flange DN25, DN40, DN50, DN80, DN100, DN150

Flange 1", 1"1/2, 2", 3", 4", 6"

## Ordering chart - accessories for measuring device Type 8185 (has to be ordered separately)

Specifications	Item no.
Set with 2 reductions M20 x 1.5/NPT1/2" + 2 neoprene flat seals for cable gland + 2 screw-plugs M20 x 1.5	551 782
Spare cable with gravity weight - 10 m	560 769
Spare rod - 2 m	on request
Clamp collar	559 765
Hart-USB Modem	560 177
Set with a display/configuration module, a transparent cover and a seal ring	559 279
Set with a transparent cover and a seal ring	561 006

**Guided microwave level measuring device Type 8185 - request for quotation**

**Note**  
You can fill out the fields directly in the PDF file before printing out the form.

Please fill in and send to your local Bürkert Sales Centre\* with your inquiry or order.

Company:	Contact person:
Customer No.:	Department:
Address:	Tel. / Fax.:
Postcode / Town:	E-mail:

**Guided microwave level measuring device 8185**

Quantity:       Desired delivery date:

■ **Process fitting connection:**

**External thread**     G 3/4"       G 1"       G 1 1/2"  
                                   NPT 3/4"       NPT 1"       NPT 1 1/2"

**Flange**               DN25       DN40       DN50  
                                   DN80       DN100       DN150  
                                   ANSI 1"       ANSI 1 1/2"       ANSI 2"  
                                   ANSI 3"       ANSI 4"       ANSI 6"

■ **Sensor version:**

**Probe**               Rod       Cable

**Length**               1 m       2 m       5 m       10 m  
 Spec. length  mm (multiple of 200 mm between 600 and 4000 mm for Rod version -  
 (multiple of 200 mm between 1000 and 32000 mm for cable version)

■ **display/configuration module**       Yes       No

■ **ATEX approval**                               Yes       No

**Interconnection possibilities with other Bürkert devices**

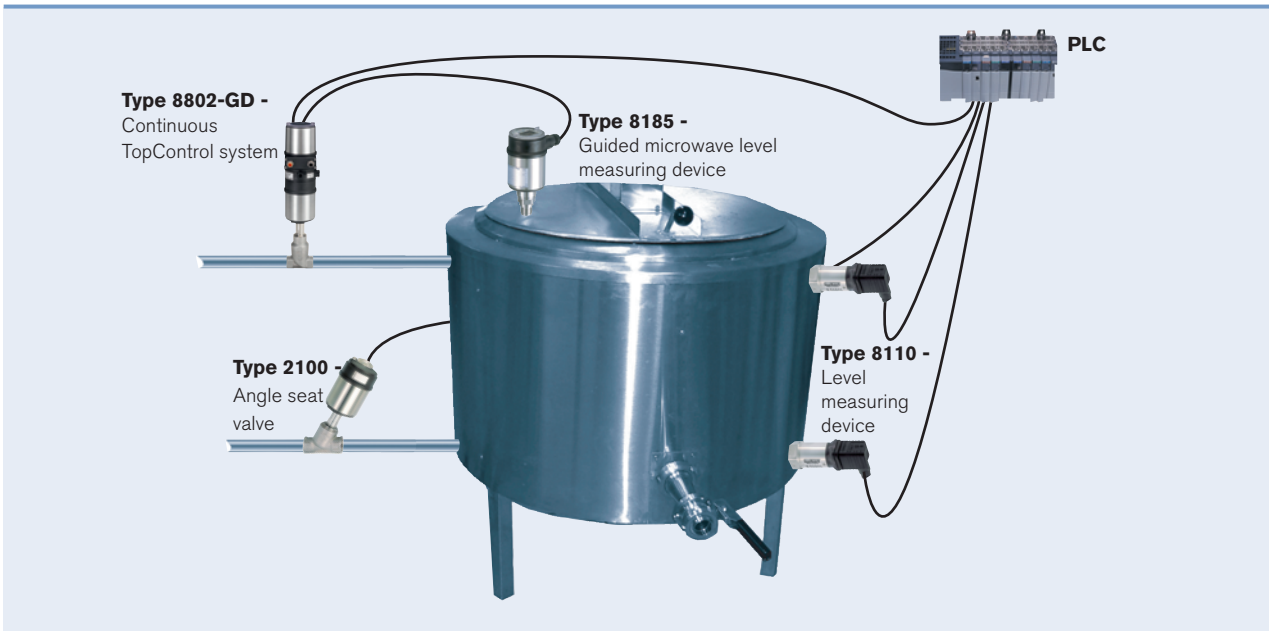

\*To find your nearest Bürkert office, click on the orange box → [www.burkert.com](http://www.burkert.com)

DTS 1000066889 EN Version: K Status: RL (released | freigegeben | valide) printed: 29.08.2013